

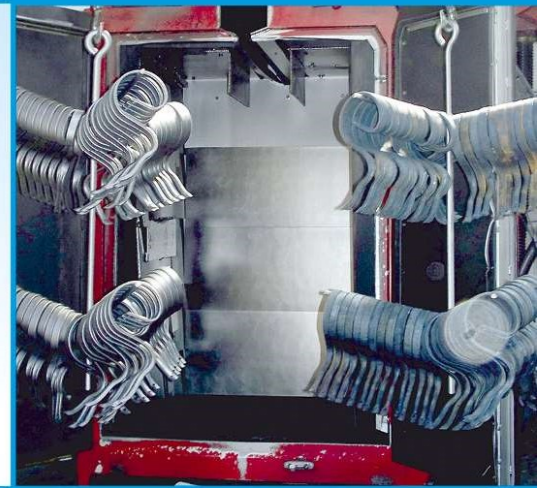

LAMATOR GmbH

Made in Germany
- seit 1906 -

Katalog / Catalog / Catalogue



LAMATOR GmbH

Prager Straße 1 · D - 04860 Torgau

Telefon: + 49 (0) 34 21 / 77 37 6 - 0

Fax: + 49 (0) 34 21 / 77 37 6 - 40

info@lamator.de · www.lamator.de

Inhaltsverzeichnis // Table of Contents // Sommaire

Federzinken in Spitzenqualität	4
Spring type tools in top quality	5
Dents souples de grande qualité	6
Gebogene Federzinken // Formed S-Tines // Dents de Ressort cintrés	8
Großfederzinken // Extra Heavy Tines // Dents de Ressort forts	15
Federzinken, steil angestellt // Spring Tines, steep angle // Dents de Ressort, en position à pic	22
OPTiFLEX Sonder-Federzinken // Special Spring Tines // Speciale Dents de Ressort.....	29
Federzinken, gerade // Spring Tines, straight // Dents de Ressort, droit	32
Überfedern // Helper Springs // Ressorts Subsidiaries	38
Sonderzinken // Special Tines // Dents Spéciaux	42
Gareeggen-Zinken // Harrow Tines // Dents herse Vibrantes	43
Spurlockerer // Track Eradicators // Efface-Traces	48
Schleppzinken (Nivellierzinken) // Levelling Tines // Dents Nivelants.....	51
Schleppzinken und Zubehör // Levelling Tines and Accessories // Dents Nivelants et Attirail.....	52
Verschleißteile // Wearing Parts // Pièces d'usure	53
Packer- und Packerzwischenfedern // Packer Springs and Intermediate Packer Springs // Ressorts Packer et Ressorts Packer intermédiaire.....	55
Schneide // Knive // Couteau	57
Federzinken Steinsammler // Spring Tine for Stone Picker // Dent de ramasseuse de pierres.....	58
Zinkenfedern // Special Springs // Ressorts Spéciaux	59
Spezialfedern // Special Springs // Ressorts Spéciaux	61
Hacktechnik // Hoe parts // Outils de bineuse	62
Rechenzinken // Rake Tines // Dents de Râteau.....	63
Wendeschar // Reversible Points // Socs Reversibles.....	64
Breitschar // Shovels // Socs larges.....	67
Klemmplatten (Zinkenhalter) für Geräterahmen im metrischen System // Clamps for metric unit frames // Brides pour des cadres du système de mesures métrique.....	69
Klemmplatten (Zinkenhalter) für Geräterahmen im metrischen System mit Überfeder // Clamps for metric unit frames with Helper Spring // Brides pour des cadres du système de mesures métrique avec Ressort Subsidiaire.....	71
Klemmplatten (Zinkenhalter) für Geräterahmen im Zoll-System // Clamps for inch unit frames // Brides pour des cadres du système de mesures reposant sur pouce	73
Planetschrauben // Cultivator Bolts // Boulons de Soc.....	74

Umschlüsselungsliste für Nachbau-Ersatzteile // Recoding list for reproduction replacement parts //	
Liste de codes pour pièces de rechange à reproduire	75
Umschlüsselungsliste für Nachbau-Ersatzteile // Recoding list for reproduction replacement parts //	
Liste de codes pour pièces de rechange à reproduire	76
Anmerkungen zu unserem Programm	82
Comments about our Program.....	83
Remarques sur notre Programme	84

Hinweis: Die unbefugte Verwendung der abgebildeten Zeichnungen stellt einen Verstoß gegen das Urheberrecht dar und wird von uns rechtlich verfolgt.

Note: The unauthorized use of the illustrated drawing constitutes a violation against copyright and is legally prosecuted by us.

Note: L'utilisation non autorisée du dessin montré est une violation constituée du droit d'auteur et sera poursuivi par nous.

Federzinken in Spitzenqualität *"Made in Germany" - made by LAMATOR*

*Federnde Werkzeuge für die optimierte Bodenbearbeitung.
Unsere Zinken und Schare vereinen auf beispielhafte Weise hohen Entwicklungsstand, moderne
Fertigung und technische Zuverlässigkeit.*

Handfeste Vorteile unserer Produkte:

- ❖ Einsatz von Silizium-Mangan-Federstahl mit gerundeten Kanten sowie hochwertigem Vergütungsstahl.
- ❖ Exakte Temperatur- und Zeitsteuerung für den gesamten Umform- und Vergütungsprozess.
- ❖ Maße und Festigkeitswerte der **LAMATOR**-Produkte werden während der laufenden Produktion überwacht und die Stellgrößen der Produktionseinrichtung werden nachjustiert, so dass Festigkeit und Maße den in der Konstruktion vorgegebenen Sollwerten entsprechen.
- ❖ Die Geometrie unserer Zinken ist entsprechend den Erfahrungen langjähriger Feldeinsätze optimiert. Die Standardzinken entsprechen in ihrer Form **DIN ISO 5678**.
- ❖ Durch Kugelstrahlen wird die Festigkeit der Zinken gesteigert und ein optimaler Haftgrund für die Lackierung geschaffen.
- ❖ Die Farbgebung der **LAMATOR**-Zinken erfolgt im Tauchverfahren mit schwarzem Einbrennlack, der durch eine nachfolgende Infrarot-Trocknung eine optimale Festigkeit erhält.
- ❖ Geprüft gem. **DIN ISO 8947** mit einer testierten Lebensdauer von 5.000.000 Lastwechseln.
- ❖ Die Verpackung der **LAMATOR**-Produkte erfolgt auf Holzpaletten mit witterungsbeständiger Schrumpffolie.
- ❖ Unterschiedliche Zinken und Schare von **LAMATOR** können miteinander kombiniert werden.
- ❖ Die vielfach bewährten Klemmplatten von **LAMATOR** sind für alle Zinken und viele Rahmenprofile verfügbar.

Spring type tools in top quality
"Made in Germany" - made by LAMATOR

Spring type tools for optimal soil and seedbed preparation.

Our spring tines and reversible points are the result of a decade long research and development. Combined with production know-how and technical reliability they result in a wide production range of best quality products in the industry. PERFECT FIT, LONG LASTING and TOP SURFACE are characteristics which result in our claim for perfection.

Some reasons why LAMATOR products are simply better:

- ❖ We use steel with a special silicon-manganese alloy, rolled, rounded edges, heat treated and oil quenched, tempered to optimal durability.
- ❖ Exact process control in production time and temperature assure proper firmness and flexibility of products for a longer life span.
- ❖ During the manufacturing process parts are subject to constant quality checks regarding tolerance and firmness.
- ❖ Due to years of experience in the tillage the tine production has constantly been optimized and match ISO standards.
- ❖ Shot peening enhances the durability of all parts compacting the surface. At the same time it prepares the surface for a better finish.
- ❖ Products are dip-painted in a high gloss lacquer and cured by infrared heat assuring a resistant finish as well as a glossy look.
- ❖ Tines are tested according to ISO DIN 8947 guaranteed to last at least 5,000,000 load change vibrations.
- ❖ LAMATOR products are bundled and packaged on pallets covered with shrink wrap.
- ❖ Different tines and points made by LAMATOR can be combined.
- ❖ A large selection of tine clamps made by LAMATOR are available to all tine and frame combinations.

Dents souples de grande qualité
"Made in Germany" - made by LAMATOR

Outils de travail souples pour un travail du sol optimal.
Nos dents et nos socs allient de façon exemplaire un niveau élevé de développement, une fabrication moderne et la fiabilité technique.

Les grands avantages de nos produits:

- ❖ Utilisation d'acier au silicium et au manganèse à bords arrondis et d'acier de finition de haute qualité.
- ❖ Pilotage précis de la température et de la durée sur l'ensemble du processus de formage et de finition.
- ❖ Les dimensions et les valeurs de résistance des produits **LAMATOR** sont surveillées en cours de production et les valeurs de réglage du dispositif de production sont réajustées permettant ainsi que la résistance et les dimensions correspondent aux valeurs prescrites dans la construction.
- ❖ La géométrie de nos dents est optimisée conformément aux longues expériences faites dans l'utilisation dans les champs. La forme des dents standard répond à la norme **DIN ISO 5678**.
- ❖ Le grenaillage permet d'améliorer la résistance des dents et d'obtenir une base d'adhérence optimale pour le laquage.
- ❖ La coloration des dents **LAMATOR** s'effectue par immersion avec un vernis à cuire noir avec une résistance optimale grâce au séchage suivant par infrarouge.
- ❖ Contrôlé conformément à **DIN ISO 8947** avec une durée de vie testée de 5.000.000 de changements de charge.
- ❖ L'emballage des produits **LAMATOR** s'effectue sur palettes de bois avec des films rétractables résistant aux intempéries.
- ❖ Il est possible de combiner entre eux des dents et des socs différents de **LAMATOR**.
- ❖ Les plaques de serrage éprouvées de **LAMATOR** sont disponibles pour toutes les dents et un grand nombre de profils de châssis.

***TURBO-Kugelstrahlen mit hochwertigem Strahlmaterial // TURBO Shot peening
using a certified shot peen material // Grenailage TURBO aux boulets d'acier***

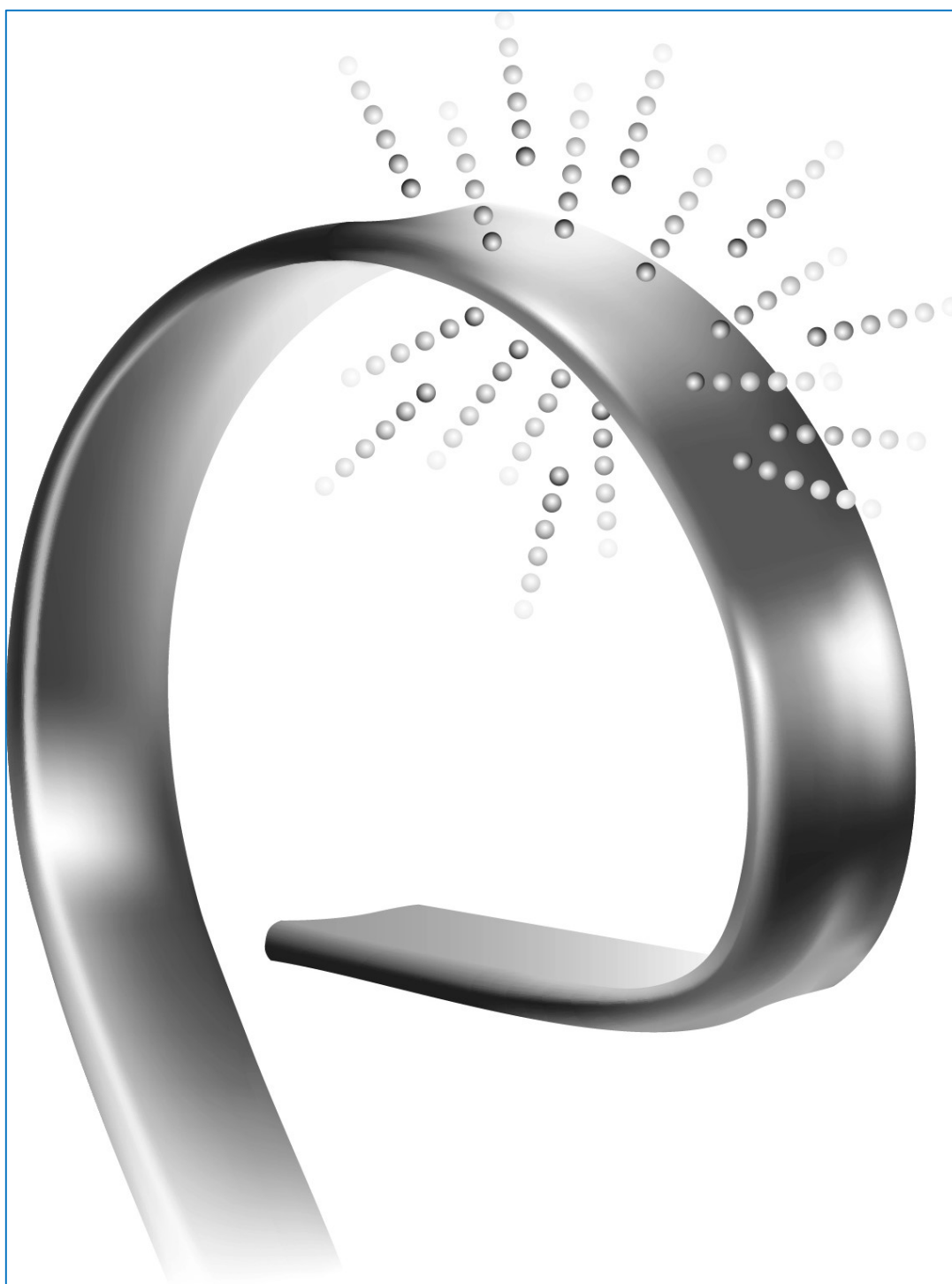

Gebogene Federzinken // Formed S-Tines // Dents de Ressort cintrés

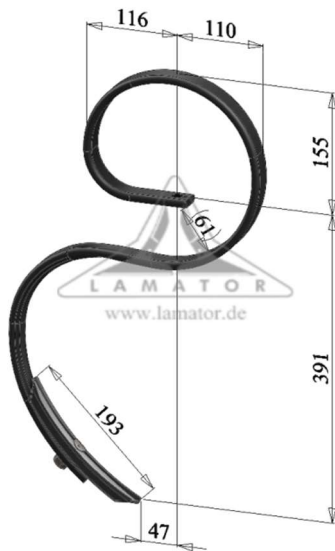

Artikelbezeichnung Description // Dénomination	Artikel-Nr. Part Number le code article	Gewicht weight // poid
❖ Federzinken Standard 32 x 10 x 560 mit Schar 40 x 6 x 200 bestehend aus: Standardzinken 32 x 10 x 560 Wendeschar 40 x 6 x 200 und Planetschraube M10 x 37 / 8.8	120 9011	3,00 kg
Spring Tine Standard 32 x 10 x 560 with point 40 x 6 x 200 consist of: Standard Tine 32 x 10 x 560 R-point 40 x 6 x 200 and cultivator bolt M10 x 37 / 8.8	120 9011	3,00 kg
Dent de Ressort Standard 32 x 10 x 560 avec soc 40 x 6 x 200 assemblé de: Dent de Ressort Standard 32 x 10 x 560 soc 40 x 6 x 200 boulon de soc M10 x 37 / 8.8	120 9011	3,00 kg
Passende Überfeder 32 x 10 Fitting Helper Spring 32 x 10 Ressort Subsidiaire approprié 32 x 10	120 9135	1,57 kg

Gebogene Federzinken // Formed S-Tines // Dents de Ressort cintrés

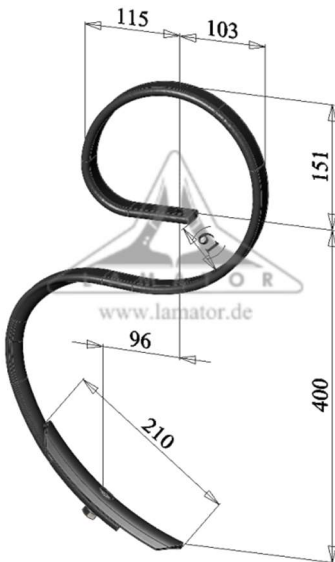
	Artikelbezeichnung Description // Dénomination	Artikel-Nr. Part Number le code article	Gewicht weight // poid
	<p>❖ Federzinken 32 x 10 Standard mit Schar 40 x 6 x 215 bestehend aus: Zinken 32 x 10 Standard Wendeschar 40 x 6 x 215 und Planetschraube M10 x 37 / 8.8</p>	<p>120 9013 120 9013 1 120 6058</p>	<p>3,05 kg 2,65 kg 0,36 kg</p>
	<p>Spring Tine 32 x 10 Standard with point 40 x 6 x 215 consist of: Tine 32 x 10 Standard R-point 40 x 6 x 215 and cultivator bolt M10 x 37 / 8.8</p>	<p>120 9013 120 9013 1 120 6058</p>	<p>3,05 kg 2,65 kg 0,36 kg</p>
	<p>Dent de Ressort 32 x 10 Standard avec soc 40 x 6 x 215 assemblé de: Dent 32 x 10 Standard soc 40 x 6 x 215 et boulon de soc M10 x 37 / 8.8</p>	<p>120 9013 120 9013 1 120 6058</p>	<p>3,05 kg 2,65 kg 0,36 kg</p>

Gebogene Federzinken // Formed S-Tines // Dents de Ressort cintrés

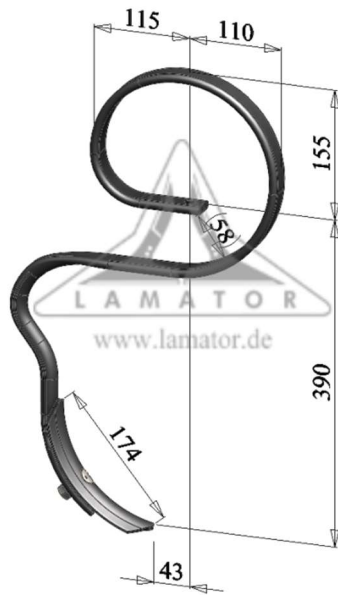

Artikelbezeichnung Description // Dénomination	Artikel-Nr. Part Number le code article	Gewicht weight // poids
<p>❖ Schnellfluss-Federzinken 32 x 10 x 560 RAU mit Schar 40 x 6 x 199 bestehend aus: Schnellfluss-Zinken 32 x 10 x 560 Wendeschar 40 x 6 x 199 und Planetschraube M10 x 37 / 8.8</p>	<p>120 0250</p> <p>120 3250 120 8601</p>	<p>3,02 kg</p> <p>2,65 kg 0,33 kg</p>
<p>Easy-Flow Spring Tine 32 x 10 x 560 RAU with point 40 x 6 x 199 consist of: Easy-Flow Tine 32 x 10 x 560 R-point 40 x 6 x 199 and cultivator bolt M10 x 37 / 8.8</p>	<p>120 0250</p> <p>120 3250 120 8601</p>	<p>3,02 kg</p> <p>2,65 kg 0,33 kg</p>
<p>Dent de Ressort Ecoulement Rapide 32 x 10 x 560 RAU avec soc 40 x 6 x 199 assemblé de: Dent Ecoulement Rapide 32 x 10 x 560 soc 40 x 6 x 199 et boulon de soc M10 x 37 / 8.8</p>	<p>120 0250</p> <p>120 3250 120 8601</p>	<p>3,02 kg</p> <p>2,65 kg 0,33 kg</p>
<p>Passende Überfeder 32 x 10 Fitting Helper Spring 32 x 10 Ressort Subsidaire approprié 32 x 10</p>	<p>120 9135</p>	<p>1,57 kg</p>

Gebogene Federzinken // Formed S-Tines // Dents de Ressort cintrés

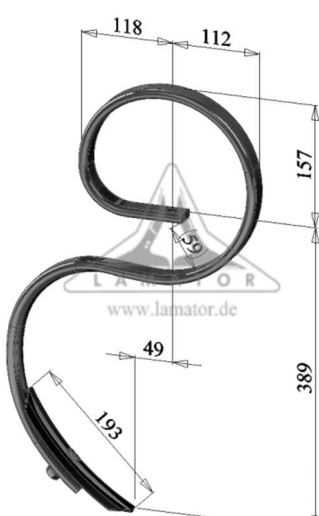
	Artikelbezeichnung Description // Dénomination	Artikel-Nr. Part Number le code article	Gewicht weight // poid
	<p>❖ Standard-Federzinken verstärkt 32 x 12 x 560 mit Schar 40 x 6 x 200 bestehend aus: Standardzinken verstärkt 32 x 12 x 560 Wendeschar 40 x 6 x 200 und Planetschraube M10 x 37 / 8.8</p>	<p>120 9028 120 8935 120 5555</p>	<p>3,37 kg 3,00 kg 0,33 kg</p>
	<p>Heavy Duty Tine 32 x 12 x 560 with point 40 x 6 x 200 consist of: Heavy Duty Tine 32 x 12 x 560 R-point 40 x 6 x 200 and cultivator bolt M10 x 37 / 8.8</p>	<p>120 9028 120 8935 120 5555</p>	<p>3,37 kg 3,00 kg 0,33 kg</p>
	<p>Dent de Ressort Standard 32 x 12 x 560 soc 40 x 6 x 200 assemblé de: Dent Standard 32 x 12 x 560 soc 40 x 6 x 200 et boulon de soc M10 x 37 / 8.8</p>	<p>120 9028 120 8935 120 5555</p>	<p>3,37 kg 3,00 kg 0,33 kg</p>
	<p>Passende Überfeder 32 x 10 Fitting Helper Spring 32 x 10 Ressort Subsidiaire approprié 32 x 10</p>	<p>120 9135</p>	<p>1,57 kg</p>

Gebogene Federzinken // Formed S-Tines // Dents de Ressort cintrés

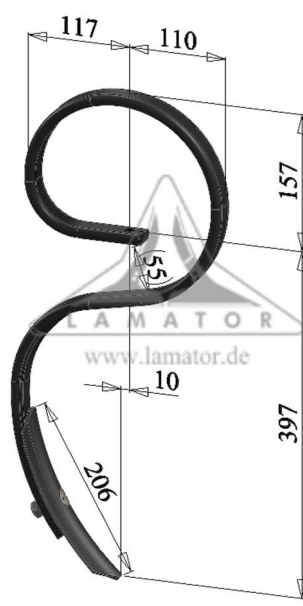
	Artikelbezeichnung Description // Dénomination	Artikel-Nr. Part Number le code article	Gewicht weight // poids
	<p>❖ Uni-Federzinken 32 x 12 x 500 schwach gebogen <i>Doublet Record</i> mit Schar 40 x 6 x 215 bestehend aus: Uni-Zinken 32 x 12 x 500 schwach gebogen <i>Doublet Record</i> Wendeschar 40 x 6 x 215 und Planetschraube M10 x 37 / 8.8</p>	<p>120 0144</p> <p>120 0044</p> <p>120 6058</p>	<p>3,09 kg</p> <p>2,69 kg</p> <p>0,36 kg</p>
	<p>Uni Spring Tine 32 x 12 x 500 slightly bent <i>Doublet Record</i> with point 40 x 6 x 215 consist of: Uni-Tine 32 x 12 x 500 slightly bent <i>Doublet Record</i> R-point 40 x 6 x 215 and cultivator bolt M10 x 37 / 8.8</p>	<p>120 0144</p> <p>120 0044</p> <p>120 6058</p>	<p>3,09 kg</p> <p>2,69 kg</p> <p>0,36 kg</p>
	<p>Dent de Ressort Uni 32 x 12 x 500 cintré doucement <i>Doublet Record</i> avec soc 40 x 6 x 215 assemblé de: Dent Uni 32 x 12 x 500 cintré doucement <i>Doublet Record</i> soc 40 x 6 x 215 et boulon de soc M10 x 37 / 8.8</p>	<p>120 0144</p> <p>120 0044</p> <p>120 6058</p>	<p>3,09 kg</p> <p>2,69 kg</p> <p>0,36 kg</p>
	<p>Passende Überfeder 32 x 10 Fitting Helper Spring 32 x 10 Ressort Subsidiaire approprié 32 x 10</p>	<p>120 9135</p>	<p>1,57 kg</p>

Gebogene Federzinken // Formed S-Tines // Dents de Ressort cintrés

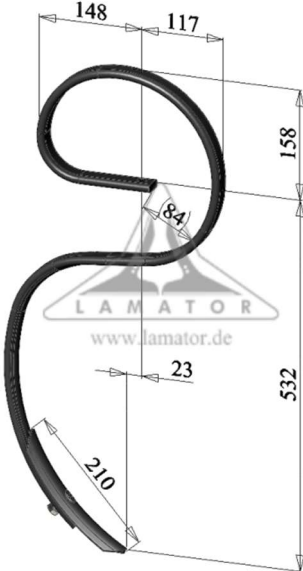
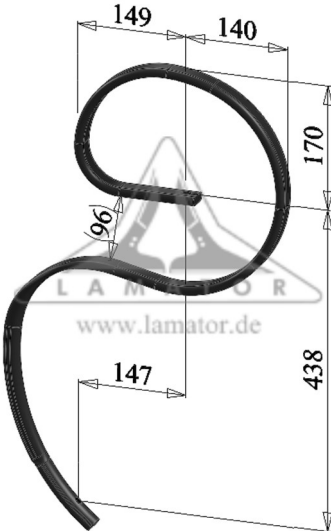
	Artikelbezeichnung Description // Dénomination	Artikel-Nr. Part Number le code article	Gewicht weight // poids
	<p>❖ Federzinken 32 x 12 x 660 große Einbauhöhe mit Schar 40 x 6 x 215 bestehend aus: Zinken 32 x 12 x 660 große Einbauhöhe Wendeschar 40 x 6 x 215 und Planetschraube M10 x 37 / 8.8</p>	120 8404	3,81 kg
	<p>High Clearance Tine 32 x 12 x 660 with point 40 x 6 x 215 consist of: High Clearance Tine 32 x 12 x 660 R-point 40 x 6 x 215 and cultivator bolt M10 x 37 / 8.8</p>	120 8404	3,81 kg
	<p>Dent de Ressort 32 x 12 x 660 de grande hauteur avec soc 40 x 6 x 215 assemblé de: Dent 32 x 12 x 660 de grande hauteur soc 40 x 6 x 215 et boulon de soc M10 x 37 / 8.8</p>	120 8404	3,81 kg
	<p>❖ Zinken 32 x 12 x 645 für Rahmenprofil 3" ohne Schar Sonderzinken mit optimierter Geometrie, besonders geeignet für Breitschare</p>	120 9110	3,69 kg
	<p>Extra Heavy Tine 32 x 12 x 645 for frame section of 3" without point Special tine with optimized shape, specially adapted for duck foot and sweeps</p>	120 9110	3,69 kg
	<p>Dent Spécial 32 x 12 x 645 pour cadres de 3" sans soc Dent Spécial d'une géométrie optimisée, surtout approprié aux socs larges et cadres grands</p>	120 9110	3,69 kg

Gebogene Federzinken // Formed S-Tines // Dents de Ressort cintrés

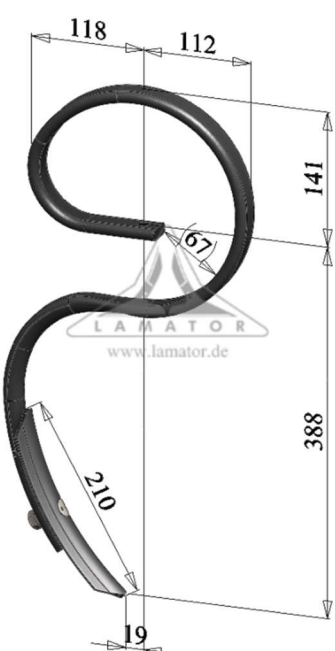
	Artikelbezeichnung Description // Dénomination	Artikel-Nr. Part Number le code article	Gewicht weight // poids
	<p>❖ Federzinken 32 x 12 Kongskilde SQ mit Schar 40 x 6 x 215 bestehend aus: Federzinken 32 x 12 <i>Kongskilde SQ</i> Wendeschar 40 x 6 x 215 und Planetschraube M10 x 37 / 8.8</p>	<p>120 0261</p> <p>120 0260 120 6058</p>	<p>3,05 kg</p> <p>2,65 kg 0,36 kg</p>
	<p>Spring Tine 32 x 12 Kongskilde SQ with point 40 x 6 x 215 consist of: Spring Tine 32 x 12 <i>Kongskilde SQ</i> R-point 40 x 6 x 215 and cultivator bolt M10 x 37 / 8.8</p>	<p>120 0261</p> <p>120 0260 120 6058</p>	<p>3,05 kg</p> <p>2,65 kg 0,36 kg</p>
	<p>Dent de Ressort 32 x 12 Kongskilde SQ avec soc 40 x 6 x 215 assemblé de: Dent de ressort 32 x 12 <i>Kongskilde SQ</i> soc 40 x 6 x 215 et boulon de soc M10 x 37 / 8.8</p>	<p>120 0261</p> <p>120 0260 120 6058</p>	<p>3,05 kg</p> <p>2,65 kg 0,36 kg</p>

Großfederzinken // Extra Heavy Tines // Dents de Ressort forts

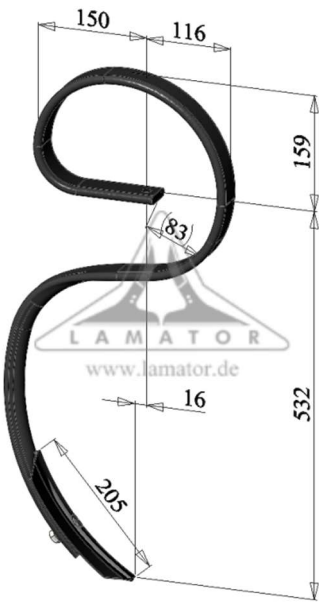
	Artikelbezeichnung Description // Dénomination	Artikel-Nr. Part Number le code article	Gewicht weight // poid
	<p>❖ Großfederzinken 45 x 12 x 660 mit Schar 50 x 6 x 215 bestehend aus: Großzinken 45 x 12 x 660 Wendeschar 50 x 6 x 215 und Planetschraube M10 x 45 / 8.8</p> <p>Extra Heavy Tine 45 x 12 x 660 with point 50 x 6 x 215 consist of: Extra Heavy Tine 45 x 12 x 660 R-point 50 x 6 x 215 and cultivator bolt M10 x 45 / 8.8</p> <p>Dent de Ressort Fort 45 x 12 x 660 avec soc 50 x 6 x 215 assemblé de: Dent Fort 45 x 12 x 660 soc 50 x 6 x 215 et boulon de soc M10 x 45 / 8.8</p>	<p>120 8381</p> <p>120 8381</p> <p>120 8381</p>	<p>5,40 kg</p> <p>4,92 kg 0,43 kg</p> <p>5,40 kg</p> <p>4,92 kg 0,43 kg</p> <p>5,40 kg</p> <p>4,92 kg 0,43 kg</p>
	<p>Passende Überfeder 45 x 10 Fitting Helper Spring 45 x 10 Ressort Subsidiaire approprié 45 x 10</p>	<p>120 9138</p>	<p>2,57 kg</p>

Großfederzinken // Extra Heavy Tines // Dents de Ressort forts

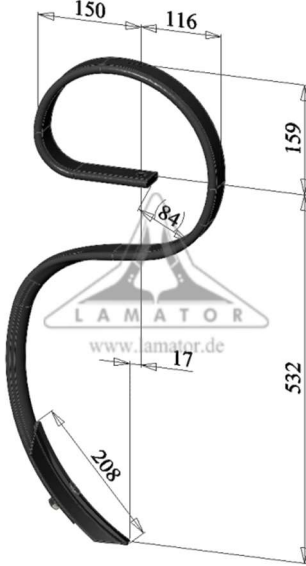
	Artikelbezeichnung Description // Dénomination	Artikel-Nr. Part Number le code article	Gewicht weight // poid
	<p>❖ Großfederzinken 45 x 12 x 660 mit Schar 60 x 6 x 215 bestehend aus: Großzinken 45 x 12 x 660 Wendeschar 60 x 6 x 215 und Planetschraube M10 x 45 / 8.8</p>	<p>120 8382</p> <p>120 8252 120 8531</p>	<p>5,47 kg</p> <p>4,92 kg 0,50 kg</p>
	<p>Extra Heavy Tine 45 x 12 x 660 with point 60 x 6 x 215 consist of: Extra Heavy Tine 45 x 12 x 660 R-point 60 x 6 x 215 and cultivator bolt M10 x 45 / 8.8</p>	<p>120 8382</p> <p>120 8252 120 8531</p>	<p>5,47 kg</p> <p>4,92 kg 0,50 kg</p>
	<p>Dent de Ressort Fort 45 x 12 x 660 avec soc 60 x 6 x 215 assemblé de: Dent Fort 45 x 12 x 660 soc 60 x 6 x 215 et boulon de soc M10 x 45 / 8.8</p>	<p>120 8382</p> <p>120 8252 120 8531</p>	<p>5,47 kg</p> <p>4,92 kg 0,50 kg</p>
	<p>Passende Überfeder 45 x 10 Fitting Helper Spring 45 x 10 Ressort Subsidiaire approprié 45 x 10</p>	<p>120 9138</p>	<p>2,57 kg</p>

Großfederzinken // Extra Heavy Tines // Dents de Ressort forts

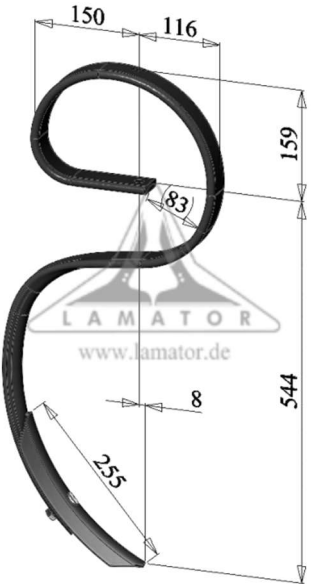
	Artikelbezeichnung Description // Dénomination	Artikel-Nr. Part Number le code article	Gewicht weight // poid
	<p>❖ Großfederzinken 45 x 12 x 660 mit Schar 60 x 6 x 260 bestehend aus: Großzinken 45 x 12 x 660 Wendeschar 60 x 6 x 260 und Planetschraube M10 x 45 / 8.8</p> <p>Extra Heavy Tine 45 x 12 x 660 with point 60 x 6 x 260 consist of: Extra Heavy Tine 45 x 12 x 660 R-point 60 x 6 x 260 and cultivator bolt M10 x 45 / 8.8</p> <p>Dent de Ressort Fort 45 x 12 x 660 avec soc 60 x 6 x 260 assemblé de: Dent Fort 45 x 12 x 660 soc 60 x 6 x 260 et boulon de soc M10 x 45 / 8.8</p>	<p>120 8383</p> <p>120 8383</p> <p>120 8383</p>	<p>5,63 kg</p> <p>4,92 kg 0,66 kg</p> <p>5,63 kg</p> <p>4,92 kg 0,66 kg</p> <p>5,63 kg</p> <p>4,92 kg 0,66 kg</p>
	<p>Passende Überfeder 45 x 10 Fitting Helper Spring 45 x 10 Ressort Subsidiaire approprié 45 x 10</p>	<p>120 9138</p>	<p>2,57 kg</p>

Großfederzinken // Extra Heavy Tines // Dents de Ressort forts

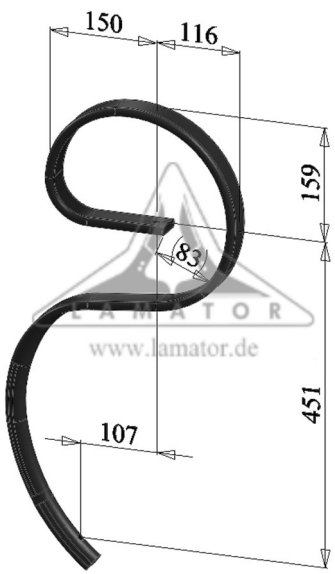
	Artikelbezeichnung Description // Dénomination	Artikel-Nr. Part Number le code article	Gewicht weight // poid
	<p>❖ Großzinken 45 x 12 x 650 Solbjerg ohne Schar Sonderzinken mit optimierter Geometrie, besonders geeignet für Breitschare</p> <p>Extra Heavy Tine 45 x 12 x 650 Solbjerg without point Special tine with optimized shape, specially adapted for duck foot and sweeps</p> <p>Dent Fort 45 x 12 x 650 Solbjerg sans soc Dent spécial d'une géométrie optimisée, surtout approprié aux socs larges et cadres grands</p>	<p>120 8251</p> <p>120 8251</p> <p>120 8251</p>	<p>4,89 kg</p> <p>4,89 kg</p> <p>4,89 kg</p>
	<p>Passende Überfeder 45 x 10 Fitting Helper Spring 45 x 10 Ressort Subsidiaire approprié 45 x 10</p>	<p>120 9138</p>	<p>2,57 kg</p>

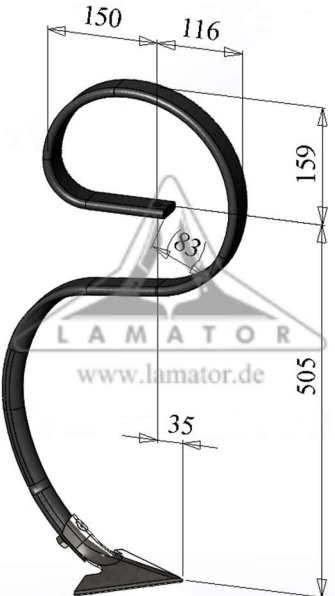
	<p>❖ Großzinken 45 x 12 x 650 Solbjerg mit Gänsefußschar "Made in Mexico" 190 mm x 6,25 mm</p> <p>Extra Heavy Tine 45 x 12 x 650 Solbjerg with Duck Foot "Made in Mexico" 190 mm x 6,25 mm</p> <p>Dent Fort 45 x 12 x 650 Solbjerg avec Soc Patte d'Oie "Made in Mexico" 190 mm x 6,25 mm</p>	<p>120 8254</p> <p>120 8584</p> <p>120 8254</p> <p>120 8584</p> <p>120 8254</p> <p>120 8584</p>	<p>5,62 kg</p> <p>0,69 kg</p> <p>5,62 kg</p> <p>0,69 kg</p> <p>5,62 kg</p> <p>0,69 kg</p>
---	--	--	--

Großfederzinken // Extra Heavy Tines // Dents de Ressort forts

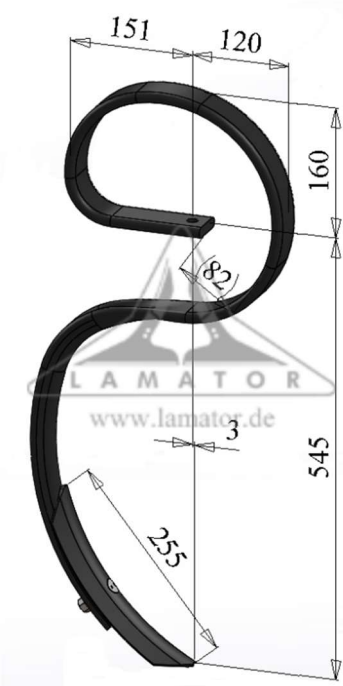
	Artikelbezeichnung Description // Dénomination	Artikel-Nr. Part Number le code article	Gewicht weight // poids
	<p>❖ Großfederzinken 50 x 13 x 660 Bohrung Ø 13 mit Schar 60 x 6 x 260 bestehend aus: Großzinken 50 x 13 x 660 mit Bohrung Ø 13 Wendeschar 60 x 6 x 260 und Planetschraube M10 x 50 / 8.8</p>	<p>120 9351</p> <p>120 9350</p> <p>120 8521</p>	<p>6,67 kg</p> <p>5,96 kg</p> <p>0,66 kg</p>
	<p>Extra Heavy Spring Tine 50 x 13 x 660 with Ø 13 with point 60 x 6 x 260 consist of: Extra Heavy Tine 50 x 13 x 660 with Ø 13 R-point 60 x 6 x 260 and cultivator bolt M10 x 50 / 8.8</p>	<p>120 9351</p> <p>120 9350</p> <p>120 8521</p>	<p>6,67 kg</p> <p>5,96 kg</p> <p>0,66 kg</p>
	<p>Dent de Ressort Fort 50 x 13 x 660 avec Ø 13 avec soc 60 x 6 x 260 assemblé de: Dent Fort 50 x 13 x 660 avec Ø 13 soc 60 x 6 x 260 et boulon de soc M10 x 50 / 8.8</p>	<p>120 9351</p> <p>120 9350</p> <p>120 8521</p>	<p>6,67 kg</p> <p>5,96 kg</p> <p>0,66 kg</p>
	<p>Passende Überfeder 50 x 13 Fitting Helper Spring 50 x 13 Ressort Subsidiaire approprié 50 x 13</p>	<p>120 9352</p>	<p>3,72 kg</p>

Großfederzinken // Extra Heavy Tines // Dents de Ressort forts

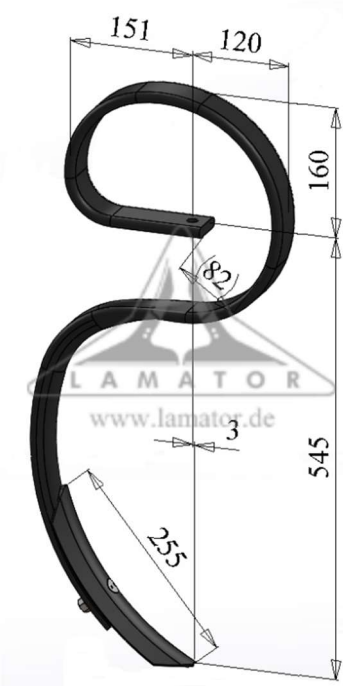
	Artikelbezeichnung Description // Dénomination	Artikel-Nr. Part Number le code article	Gewicht weight // poids
	<p>❖ Großfederzinken 50 x 13 x 660 Bohrung Ø 16 mit Schar 60 x 6 x 260 bestehend aus: Großzinken 50 x 13 x 660 mit Bohrung Ø 16 Wendeschar 60 x 6 x 260 und Planetschraube M10 x 50 / 8.8</p>	<p>120 9351 1</p> <p>120 9350 1 120 8521</p>	<p>6,67 kg</p> <p>5,96 kg 0,66 kg</p>
	<p>Extra Heavy Spring Tine 50 x 13 x 660 with Ø 16 with point 60 x 6 x 260 consist of: Extra Heavy Tine 50 x 13 x 660 with Ø 16 R-point 60 x 6 x 260 and cultivator bolt M10 x 50 / 8.8</p>	<p>120 9351 1</p> <p>120 9350 1 120 8521</p>	<p>6,67 kg</p> <p>5,96 kg 0,66 kg</p>
	<p>Dent de Ressort Fort 50 x 13 x 660 avec Ø 16 avec soc 60 x 6 x 260 assemblé de: Dent Fort 50 x 13 x 660 avec Ø 16 soc 60 x 6 x 260 et boulon de soc M10 x 50 / 8.8</p>	<p>120 9351 1</p> <p>120 9350 1 120 8521</p>	<p>6,67 kg</p> <p>5,96 kg 0,66 kg</p>
	<p>Passende Überfeder 50 x 13 mit Ø 16 Fitting Helper Spring 50 x 13 with Ø 16 Ressort Subsidiaire approprié 50 x 13 avec Ø 16</p>	<p>120 9352 1</p>	<p>3,72 kg</p>

Großfederzinken // Extra Heavy Tines // Dents de Ressort forts

	Artikelbezeichnung Description // Dénomination	Artikel-Nr. Part Number le code article	Gewicht weight // poids
	<p>❖ Großfederzinken 60 x 12 x 660 mit Schar 60 x 6 x 260 bestehend aus: Großzinken 60 x 12 x 660 Wendeschar 60 x 6 x 260 und Planetschraube M10 x 50 / 8.8</p>	<p>120 9361</p> <p>120 9360 120 8521</p>	<p>7,61 kg</p> <p>6,89 kg 0,66 kg</p>
	<p>Extra Heavy Spring Tine 60 x 12 x 660 with point 60 x 6 x 260 consist of: Extra Heavy Tine 60 x 12 x 660 R-point 60 x 6 x 260 and cultivator bolt M10 x 50 / 8.8</p>	<p>120 9361</p> <p>120 9360 120 8521</p>	<p>7,61 kg</p> <p>6,89 kg 0,66 kg</p>
	<p>Dent de Ressort Fort 60 x 12 x 660 avec soc 60 x 6 x 260 assemblé de: Dent Fort 60 x 12 x 660 Soc 60 x 6 x 260 boulon de soc M10 x 50 / 8.8</p>	<p>120 9361</p> <p>120 9360 120 8521</p>	<p>7,61 kg</p> <p>6,89 kg 0,66 kg</p>
	<p>Passende Überfeder 60 x 12 Fitting Helper Spring 60 x 12 Ressort Subsidiaire approprié 60 x 12</p>	<p>120 9362</p>	<p>4,24 kg</p>

**Federzinken, steil angestellt // Spring Tines, steep angle // Dents de Ressort,
en position à pic**

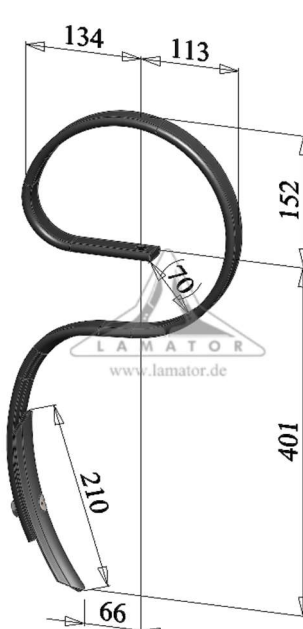
	Artikelbezeichnung Description // Dénomination	Artikel-Nr. Part Number le code article	Gewicht weight // poid
	<p>❖ Federzinken 32 x 10 Kverneland KK300502 mit Schar 40 x 6 x 215 bestehend aus: Zinken 32 x 10 Wendeschar 40 x 6 x 215 und Planetschraube M10 x 37 / 8.8</p>	<p>120 0263</p> <p>120 0262 120 6058</p>	<p>2,82 kg</p> <p>2,42 kg 0,36 kg</p>
	<p>Spring Tine 32 x10 Kverneland KK300502 with point 40 x 6 x 215 consist of: Tine 32 x 10 R-point 40 x 6 x 215 and cultivator bolt M10 x 45 / 8.8</p>	<p>120 0263</p> <p>120 0262 120 6058</p>	<p>2,82 kg</p> <p>2,42 kg 0,36 kg</p>
	<p>Dent de Ressort 32 x 10 Kverneland KK300502 avec soc 40 x 6 x 215 assemblé de: Dent 32 x 10 Soc 40 x 6 x 215 et boulon de soc M10 x 37 / 8.8</p>	<p>120 0263</p> <p>120 0262 120 6058</p>	<p>2,82 kg</p> <p>2,42 kg 0,36 kg</p>

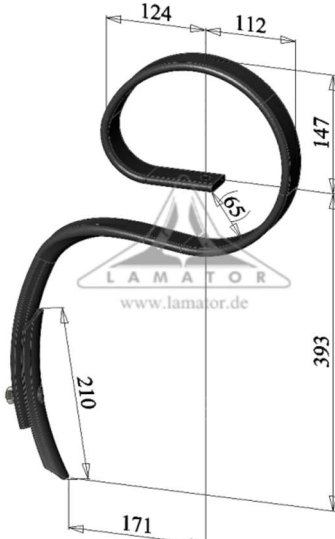
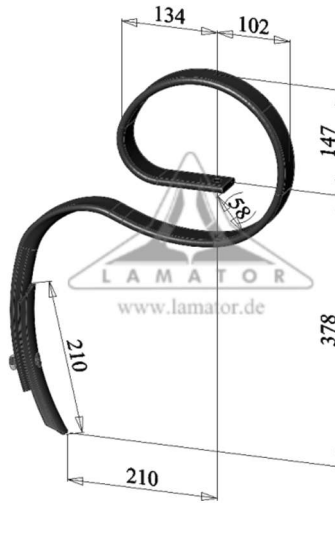

Federzinken, steil angestellt // Spring Tines, steep angle // Dents de Ressort, en position à pic

	Artikelbezeichnung Description // Dénomination	Artikel-Nr. Part Number le code article	Gewicht weight // poids
	<p>❖ Federzinken 45 x 10 Agrilla Nova mit Schar 40 x 6 x 215 bestehend aus: Zinken 45 x 10 <i>Agrilla Nova</i> Wendeschar 40 x 6 x 215 und Planetschraube M10 x 45 / 8.8</p> <p>Spring Tine 45 x 10 Agrilla Nova with point 40 x 6 x 215 consist of: Tine 45 x 10 <i>Agrilla Nova</i> R-point 40 x 6 x 215 and cultivator bolt M10 x 45 / 8.8</p> <p>Dent de Ressort 45 x 10 Agrilla Nova avec soc 40 x 6 x 215 assemblé de: Dent 45 x 10 <i>Agrilla Nova</i> soc 40 x 6 x 215 et boulon de soc M10 x 45 / 8.8</p>	<p>120 9123</p> <p>120 9122 120 6058</p> <p>120 9123</p> <p>120 9122 120 6058</p> <p>120 9123</p> <p>120 9122 120 6058</p>	<p>3,88 kg</p> <p>3,48 kg 0,36 kg</p> <p>3,88 kg</p> <p>3,48 kg 0,36 kg</p> <p>3,88 kg</p> <p>3,48 kg 0,36 kg</p>
	<p>❖ Federzinken 45 x 10 Agrilla Universal mit Schar 40 x 6 x 215 bestehend aus: Zinken 45 x 10 <i>Agrilla Universal</i> Wendeschar 40 x 6 x 215 und Planetschraube M10 x 45 / 8.8</p> <p>Spring Tine 45 x 10 Agrilla Universal with point 40 x 6 x 215 consist of: Tine 45 x 10 <i>Agrilla Universal</i> R-point 40 x 6 x 215 and cultivator bolt M10 x 45 / 8.8</p> <p>Dent de Ressort 45 x 10 Agrilla Universal avec soc 40 x 6 x 215 assemblé de: Dent 45 x 10 <i>Agrilla Universal</i> soc 40 x 6 x 215 et boulon de soc M10 x 45 / 8.8</p>	<p>120 9171</p> <p>120 9171 1 120 6058</p> <p>120 9171</p> <p>120 9171 1 120 6058</p> <p>120 9171</p> <p>120 9171 1 120 6058</p>	<p>4,12 kg</p> <p>3,71 kg 0,36 kg</p> <p>4,12 kg</p> <p>3,71 kg 0,36 kg</p> <p>4,12 kg</p> <p>3,71 kg 0,36 kg</p>

**Federzinken, steil angestellt // Spring Tines, steep angle // Dents de Ressort,
en position à pic**

	Artikelbezeichnung Description // Dénomination	Artikel-Nr. Part Number le code article	Gewicht weight // poids
	<p>❖ Federzinken 45 x 10 Agrilla Super mit Schar 40 x 6 x 215 bestehend aus: Zinken 45 x 10 <i>Agrilla Super</i> Wendeschar 40 x 6 x 215 und Planetschraube M10 x 45 / 8.8</p>	<p>120 9173</p> <p>120 9173 1 120 6058</p>	<p>3,68 kg</p> <p>3,28 kg 0,36 kg</p>
	<p>Spring Tine 45 x 10 Agrilla Super with point 40 x 6 x 215 consist of: Tine 45 x 10 <i>Agrilla Super</i> R-point 40 x 6 x 215 and cultivator bolt M10 x 45 / 8.8</p>	<p>120 9173</p> <p>120 9173 1 120 6058</p>	<p>3,68 kg</p> <p>3,28 kg 0,36 kg</p>
	<p>Dent de Ressort 45 x 10 Agrilla Super avec soc 40 x 6 x 215 assemblé de: Dent 45 x 10 <i>Agrilla Super</i> soc 40 x 6 x 215 et boulon de soc M10 x 45 / 8.8</p>	<p>120 9173</p> <p>120 9173 1 120 6058</p>	<p>3,68 kg</p> <p>3,28 kg 0,36 kg</p>

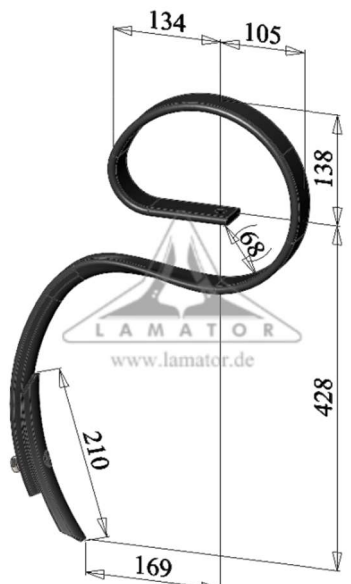
Federzinken, steil angestellt // Spring Tines, steep angle // Dents de Ressort, en position à pic

	Artikelbezeichnung Description // Dénomination	Artikel-Nr. Part Number le code	Gewicht weight // poids
	<p>❖ Federzinken 45 x 10 Agrilla Cobra mit Schar 40 x 6 x 215 bestehend aus: Zinken 45 x 10 Agrilla Cobra Wendeschar 40 x 6 x 215 und Planetschraube M10 x 45 / 8.8</p> <p>Spring Tine 45 x 10 Agrilla Cobra with point 40 x 6 x 215 consist of: Tine 45 x 10 Agrilla Cobra R-point 40 x 6 x 215 and cultivator bolt M 10 x 45 / 8.8</p> <p>Dent de Ressort 45 x 10 Agrilla Cobra avec soc 40 x 6 x 215 assemblé de: Dent 45 x 10 Agrilla Cobra soc 40 x 6 x 215 et boulon de soc M10 x 45 / 8.8</p>	<p>120 9175</p> <p>120 9175 1 120 6058</p> <p>120 9175</p> <p>120 9175 1 120 6058</p> <p>120 9175</p> <p>120 9175 1 120 6058</p>	<p>4,00 kg</p> <p>3,60 kg 0,36 kg</p> <p>4,00 kg</p> <p>3,60 kg 0,36 kg</p> <p>4,00 kg</p> <p>3,60 kg 0,36 kg</p>
	<p>❖ Federzinken 45 x 10 Agrilla Cobra passend für Rahmenprofil 70 x 70 mit Schar 40 x 6 x 215 bestehend aus: Zinken 45 x 10 Agrilla Cobra Wendeschar 40 x 6 x 215 und Planetschraube M10 x 45 / 8.8</p> <p>Spring Tine 45 x 10 Agrilla Cobra for frame transection 70 x 70 with point 40 x 6 x 215 consist of: Tine 45 x 10 Agrilla Cobra R-point 40 x 6 x 215 and cultivator bolt M 10 x 45 / 8.8</p> <p>Dent de Ressort 45 x 10 Agrilla Cobra pour section transversale du cadre 70 x 70 avec soc 40 x 6 x 215 assemblé de: Dent 45 x 10 Agrilla Cobra soc 40 x 6 x 215 et boulon de soc M10 x 45 / 8.8</p>	<p>120 9177</p> <p>120 9177 1 120 6058</p> <p>120 9177</p> <p>120 9177 1 120 6058</p> <p>120 9177</p> <p>120 9177 1 120 6058</p>	<p>4,01 kg</p> <p>3,61 kg 0,36 kg</p> <p>4,01 kg</p> <p>3,61 kg 0,36 kg</p> <p>4,01 kg</p> <p>3,61 kg 0,36 kg</p>

Federzinken, steil angestellt // Spring Tines, steep angle // Dents de Ressort, en position à pic

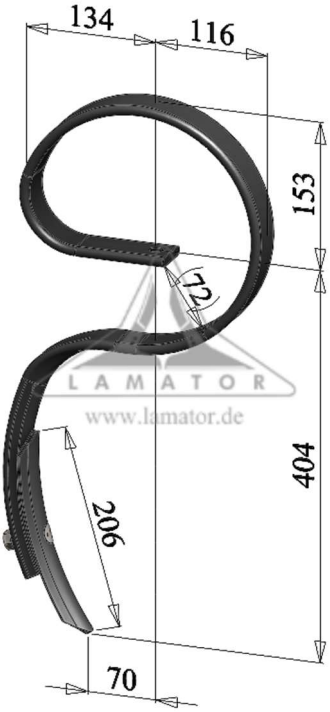
	Artikelbezeichnung Description // Dénomination	Artikel-Nr. Part Number le code article	Gewicht weight // poids
	<p>❖ Federzinken 45 x 10 Kverneland KK300500 mit Schar 40 x 6 x 215 bestehend aus: Zinken 45 x 10 KK300500 Wendeschar 40 x 6 x 215 und Planetschraube M10 x 45 / 8.8</p>	<p>120 0265</p> <p>3,75 kg</p>	
	<p>Spring Tine 45 x 10 Kverneland KK300500 with point 40 x 6 x 215 consist of: Tine 45 x 10 KK300500 R-point 40 x 6 x 215 and cultivator bolt M10 x 45 / 8.8</p>	<p>120 0265</p> <p>3,75 kg</p>	
	<p>Dent de Ressort 45 x 10 Kverneland KK300500 avec soc 40 x 6 x 215 assemblé de: Dent 45 x 10 KK300500 soc 40 x 6 x 215 et boulon de soc M10 x 45 / 8.8</p>	<p>120 0265</p> <p>3,75 kg</p>	

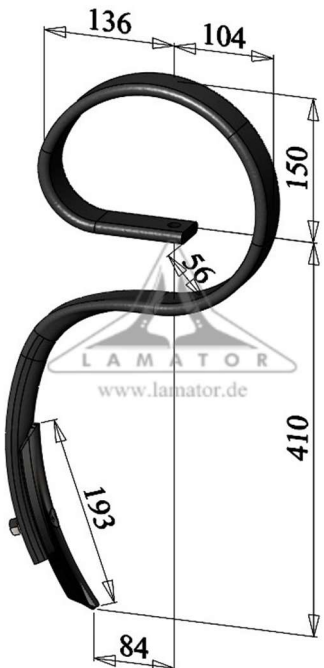
	<p>❖ Federzinken 45 x 12 x 520 mit Schar 40 x 6 x 200 bestehend aus: Zinken 45 x 12 x 520 Wendeschar 40 x 6 x 200 und Planetschraube M10 x 45 / 8.8</p>	<p>120 9146</p> <p>4,39 kg</p>	
	<p>Spring Tine 45 x 12 x 520 with point 40 x 6 x 200 consist of: Tine 45 x 12 x 520 R-point 40 x 6 x 200 and cultivator bolt M10 x 45 / 8.8</p>	<p>120 9146</p> <p>4,39 kg</p>	
	<p>Dent de Ressort 45 x 12 x 520 avec soc 40 x 6 x 200 assemblé de: Dent 45 x 12 x 520 Soc 40 x 6 x 200 et boulon de soc M10 x 45 / 8.8</p>	<p>120 9146</p> <p>4,39 kg</p>	



**Federzinken, steil angestellt // Spring Tines, steep angle // Dents de Ressort,
en position à pic**

	Artikelbezeichnung Description // Dénomination	Artikel-Nr. Part Number le code article	Gewicht weight // poids
	<p>❖ Federzinken 45 x 12 x 475 Kulti-Kompakt wie Agrilla Nova mit Schar 40 x 6 x 200 bestehend aus: Zinken 45 x 12 x 475 <i>Kulti-Kompakt</i> Wendeschar 40 x 6 x 200 und Planetschraube M10 x 45 / 8.8</p>	<p>120 9121</p> <p>120 9120 120 5555</p>	<p>4,50 kg</p> <p>4,13 kg 0,33 kg</p>
	<p>Spring Tine 45 x 12 x 475 Kulti-Kompakt like Agrilla Nova with point 40 x 6 x 200 consist of: Tine 45 x 12 x 475 <i>Kulti-Kompakt</i> R-point 40 x 6 x 200 and cultivator bolt M10 x 45 / 8.8</p>	<p>120 9121</p> <p>120 9120 120 5555</p>	<p>4,50 kg</p> <p>4,13 kg 0,33 kg</p>
	<p>Dent de Ressort 45 x 12 x 475 Kulti-Kompakt comme Agrilla Nova avec soc 40 x 6 x 200 assemblé de: Dent 45 x 12 x 475 <i>Kulti-Kompakt</i> Soc 40 x 6 x 200 et boulon de soc M10 x 45 / 8.8</p>	<p>120 9121</p> <p>120 9120 120 5555</p>	<p>4,50 kg</p> <p>4,13 kg 0,33 kg</p>

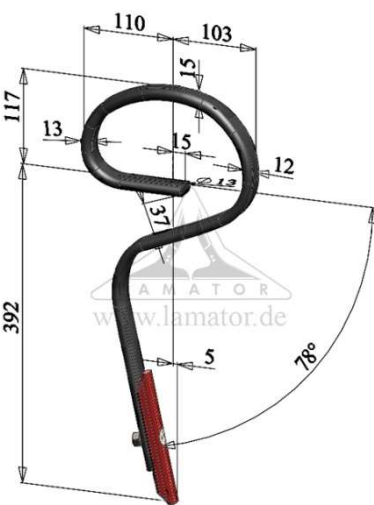

**Federzinken, steil angestellt // Spring Tines, steep angle // Dents de Ressort,
en position à pic**

	Artikelbezeichnung Description // Dénomination	Artikel-Nr. Part Number le code article	Gewicht weight // poids
	<p>❖ Federzinken 45 x 12 x 560 mit Schar 40 x 6 x 200 bestehend aus: Zinken 45 x 12 x 560 Wendeschar 40 x 6 x 200 Planetschraube M10 x 45 / 8.8</p>	<p>120 9125</p> <p>120 9124 120 5555</p>	<p>4,73 kg</p> <p>4,36 kg 0,33 kg</p>
	<p>Spring Tine 45 x 12 x 560 with point 40 x 6 x 200 consist of: Tine 45 x 12 x 560 R-point 40 x 6 x 200 and cultivator bolt M10 x 45 / 8.8</p>	<p>120 9125</p> <p>120 9124 120 5555</p>	<p>4,73 kg</p> <p>4,36 kg 0,33 kg</p>
	<p>Dent de Ressort 45 x 12 x 560 avec soc 40 x 6 x 200 assemblé de: Dent 45 x 12 x 560 soc 40 x 6 x 200 et boulon de soc M10 x 45 / 8.8</p>	<p>120 9125</p> <p>120 9124 120 5555</p>	<p>4,73 kg</p> <p>4,36 kg 0,33 kg</p>
	<p>Passende Überfeder 45 x 10 Fitting Helper Spring 45 x 10 Ressort Subsidaire approprié 45 x 10</p>	<p>120 9138</p>	<p>2,57 kg</p>

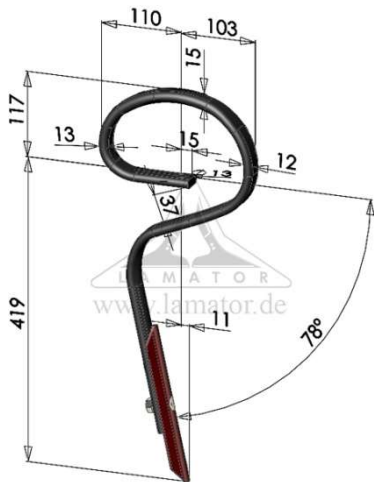

OPTiFLEX Sonder-Federzinken // Special Spring Tines // Speciale Dents de Ressort

	Artikelbezeichnung Description // Dénomination	Artikel-Nr. Part Number le code article	Gewicht weight // poid
	<p>❖ Sonder-Federzinken 32 x 12 „OPTiFLEX“, gerade mit Schar 40 x 8 x 160 gerade bestehend aus: Sonder-Zinken 32 x 12 „OPTiFLEX“, gerade Wendeschar 40 x 8 x 160 gerade Planetschraube M10 x 37 / 8.8</p>	<p>150 5102</p> <p>150 5101 120 7090</p>	<p>2,77 kg</p> <p>2,36 kg 0,37 kg</p>
	<p>Special Spring Tine 32 x 12 „OPTiFLEX“, straight with point 40 x 8 x 160, straight consist of: Special Tine 32 x 12 „OPTiFLEX“, straight R-point 40 x 8 x 160, straight and cultivator bolt M10 x 37 / 8.8</p>	<p>150 5102</p> <p>150 5101 120 7090</p>	<p>2,77 kg</p> <p>2,36 kg 0,37 kg</p>
	<p>Speciale Dent de Ressort 32 x 12 „OPTiFLEX“, droit avec soc 40 x 8 x 160, droit assemblé de: Speciale Dent 32 x 12 „OPTiFLEX“, droit soc 40 x 8 x 160, droit et boulon de soc M10 x 37 / 8.8</p>	<p>150 5102</p> <p>150 5101 120 7090</p>	<p>2,77 kg</p> <p>2,36 kg 0,37 kg</p>

OPTiFLEX Sonder-Federzinken // Special Spring Tines // Speciale Dents de Ressort

	Artikelbezeichnung Description // Dénomination	Artikel-Nr. Part Number le code article	Gewicht weight // poid	
	<p>❖ Sonder-Federzinken 32 x 12 „OPTiFLEX“, gerade mit Schar 40 x 6 x 215 gerade bestehend aus: Sonder-Zinken 32 x 12 „OPTiFLEX“, gerade Wendeschar 40 x 6 x 215 gerade und Planetschraube M10 x 37 / 8.8</p>	<p>150 5103</p> <p>150 5101</p> <p>120 7059</p>	<p>2,76 kg</p> <p>2,36 kg</p> <p>0,36 kg</p>	
	<p>Special Spring Tine 32 x 12 „OPTiFLEX“, straight with point 40 x 6 x 215, straight consist of: Special Tine 32 x 12 „OPTiFLEX“, straight R-point 40 x 6 x 215, straight and cultivator bolt M10 x 37 / 8.8</p>	<p>150 5103</p> <p>150 5101</p> <p>120 7059</p>	<p>2,76 kg</p> <p>2,36 kg</p> <p>0,36 kg</p>	
	<p>Speciale Dent de Ressort 32 x 12 „OPTiFLEX“, droit avec soc 40 x 6 x 215, droit assemblé de: Speciale Dent 32 x 12 „OPTiFLEX“, droit soc 40 x 6 x 215, droit et boulon de soc M10 x 37 / 8.8</p>	<p>150 5103</p> <p>150 5101</p> <p>120 7059</p>	<p>2,76 kg</p> <p>2,36 kg</p> <p>0,36 kg</p>	
				

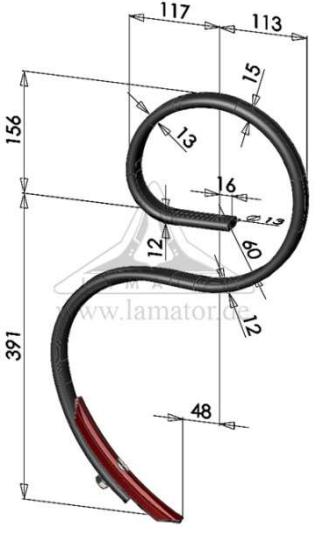
OPTiFLEX Sonder-Federzinken // Special Spring Tines // Speciale Dents de Ressort

	Artikelbezeichnung Description // Dénomination	Artikel-Nr. Part Number le code article	Gewicht weight // poids
	<p>❖ Sonder-Federzinken 32 x 12 „OPTiFLEX“, gebogen mit Schar 40 x 6 x 200 bestehend aus: Sonder-Zinken 32 x 12 „OPTiFLEX“, gebogen Wendeschar 40 x 6 x 200, gebogen Planetschraube M10 x 37 / 8.8</p>	<p>150 9028</p> <p>150 8935 120 5555</p>	<p>3,35 kg</p> <p>2,98 kg 0,33 kg</p>
	<p>Special Spring Tine 32 x 12 „OPTiFLEX“ with point 40 x 6 x 200 consist of: Special Tine 32 x 12 „OPTiFLEX“, R-point 40 x 6 x 200 and cultivator bolt M10 x 37 / 8.8</p>	<p>150 9028</p> <p>150 8935 120 5555</p>	<p>3,35 kg</p> <p>2,98 kg 0,33 kg</p>
	<p>Speciale Dent de Ressort 32 x 12 „OPTiFLEX“ avec soc 40 x 6 x 200 assemblé de: Speciale Dent 32 x 12 „OPTiFLEX“, soc reversible 40 x 6 x 200 et boulon de soc M10 x 37 / 8.8</p>	<p>150 9028</p> <p>150 8935 120 5555</p>	<p>3,35 kg</p> <p>2,98 kg 0,33 kg</p>

Federzinken, gerade // Spring Tines, straight // Dents de Ressort, droit

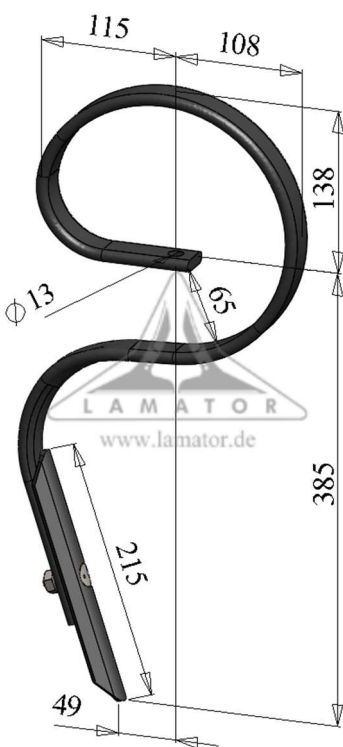
	Artikelbezeichnung Description // Dénomination	Artikel-Nr. Part Number le code article	Gewicht weight // poids
	<p>❖ Federzinken 32 x 10 für Einbauhöhe 380 mm mit Schar 40 x 6 x 215 gerade bestehend aus: Zinken 32 x 10 gerade Wendeschar 40 x 6 x 215 gerade und Planetschraube M10 x 37 / 8.8</p>	<p>120 0138</p> <p>120 0038 120 7059</p>	<p>2,61 kg</p> <p>2,21 kg 0,36 kg</p>
	<p>Spring Tine 32 x 10 installation height 380 mm with point 40 x 6 x 215 straight consist of: Tine 32 x 10 straight R-point 40 x 6 x 215 straight and cultivator bolt M10 x 37 / 8.8</p>	<p>120 0138</p> <p>120 0038 120 7059</p>	<p>2,61 kg</p> <p>2,21 kg 0,36 kg</p>
	<p>Dent de Ressort 32 x 10 pour hauteur de montage de 380 mm avec soc 40 x 6 x 215 droit assemblé de: Dent 32 x 10 droit soc 40 x 6 x 215 droit et boulon de soc M10 x 37 / 8.8</p>	<p>120 0138</p> <p>120 0038 120 7059</p>	<p>2,61 kg</p> <p>2,21 kg 0,36 kg</p>

Federzinken, gerade // Spring Tines, straight // Dents de Ressort, droit

	Artikelbezeichnung Description // Dénomination	Artikel-Nr. Part Number le code article	Gewicht weight // poids
	<p>❖ Federzinken 32 x 12 für Einbauhöhe 450 mm Kverneland KW111099002 mit Schar 40 x 6 x 215 gerade bestehend aus: Zinken 32 x 12 gerade Wendeschar 40 x 6 x 215 gerade und Planetschraube M10 x 37/8.8</p>	<p>120 0245</p> <p>120 2245 120 7059</p>	<p>3,09 kg</p> <p>2,69 kg 0,36 kg</p>
	<p>Spring Tine 32 x 12 installation height 450 mm Kverneland KW111099002 with point 40 x 6 x 215 straight consist of: Tine 32 x 12 straight R-point 40 x 6 x 215 straight and cultivator bolt M10 x 37/8.8</p>	<p>120 0245</p> <p>120 2245 120 7059</p>	<p>3,09 kg</p> <p>2,69 kg 0,36 kg</p>
	<p>Dent de Ressort 32 x 12 pour hauteur de montage de 450 mm Kverneland KW111099002 avec soc 40 x 6 x 215 droit assemblé de: Dent 32 x 12 droit soc 40 x 6 x 215 droit et boulon de soc M10 x 37/8.8</p>	<p>120 0245</p> <p>120 2245 120 7059</p>	<p>3,09 kg</p> <p>2,69 kg 0,36 kg</p>

Federzinken, gerade // Spring Tines, straight // Dents de Ressort, droit

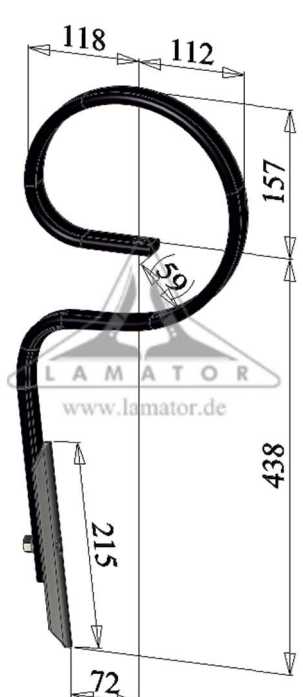
	Artikelbezeichnung Description // Dénomination	Artikel-Nr. Part Number le code article	Gewicht weight // poids
	<p>❖ Federzinken 32 x 12 Jack Pot mit Schar 40 x 6 x 215 gerade bestehend aus: Zinken 32 x 12 <i>Jack Pot</i> gerade Wendeschar 40 x 6 x 215 gerade und Planetschraube M10 x 37 / 8.8</p>	<p>120 9131</p> <p>120 9130 120 7059</p>	<p>3,11 kg</p> <p>2,72 kg 0,36 kg</p>
	<p>Spring Tine 32 x 12 Jack Pot with point 40 x 6 x 215 straight consist of: Tine 32 x 12 <i>Jack Pot</i> straight R-point 40 x 6 x 215 straight and cultivator bolt M10 x 37 / 8.8</p>	<p>120 9131</p> <p>120 9130 120 7059</p>	<p>3,11 kg</p> <p>2,72 kg 0,36 kg</p>
	<p>Dent de Ressort 32 x 12 Jack Pot avec soc 40 x 6 x 215 droit assemblé de: Dent 32 x 12 <i>Jack Pot</i> droit soc 40 x 6 x 215 droit et boulon de soc M10 x 37 / 8.8</p>	<p>120 9131</p> <p>120 9130 120 7059</p>	<p>3,11 kg</p> <p>2,72 kg 0,36 kg</p>
	<p>Passende Überfeder 32 x 10 Fitting Helper Spring 32 x 10 Ressort Subsidiaire approprié 32 x 10</p>	<p>120 9135</p>	<p>1,57 kg</p>

Federzinken, gerade // Spring Tines, straight // Dents de Ressort, droit

	Artikelbezeichnung Description // Dénomination	Artikel-Nr. Part Number le code article	Gewicht weight // poids
	<p>❖ Federzinken 32 x 12 x 490 mit Schar 40 x 6 x 215 gerade bestehend aus: Zinken 32 x 12 x 490 gerade Wendeschar 40 x 6 x 215 gerade und Planetschraube M10 x 37 / 8.8</p>	<p>120 9141 120 9140 120 7059</p>	<p>3,10 kg 2,71 kg 0,36 kg</p>
	<p>Spring Tine 32 x 12 x 490 with point 40 x 6 x 215 straight consist of: Tine 32 x 12 x 490 straight R-point 40 x 6 x 215 straight and cultivator bolt M10 x 37 / 8.8</p>	<p>120 9141 120 9140 120 7059</p>	<p>3,10 kg 2,71 kg 0,36 kg</p>
	<p>Dent de Ressort 32 x 12 x 490 avec soc 40 x 6 x 215 droit assemblé de: Dent 32 x 12 x 490 droit Soc 40 x 6 x 215 droit et boulon de soc M10 x 37 / 8.8</p>	<p>120 9141 120 9140 120 7059</p>	<p>3,10 kg 2,71 kg 0,36 kg</p>

Federzinken, gerade // Spring Tines, straight // Dents de Ressort, droit

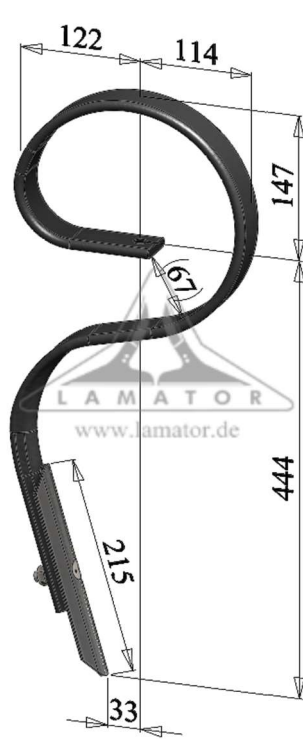
	Artikelbezeichnung Description // Dénomination	Artikel-Nr. Part Number le code article	Gewicht weight // poids
	<p>❖ Sonderzinken 45 x 10 mit Schar 40 x 6 x 215 gerade ähnlich KW111099018 bestehend aus: Zinken 45 x 10 gerade Wendeschar 40 x 6 x 215 gerade und Planetschraube M10 x 45 / 8.8</p>	<p>120 0267</p> <p>120 0266 120 7059</p>	<p>3,70 kg</p> <p>3,30 kg 0,36 kg</p>
	<p>Special Tine 45 x 10 with point 40 x 6 x 215 straight similar to KW111099018 consist of: Tine 45 x 10 straight R-point 40 x 6 x 215 straight and cultivator bolt M10 x 45 / 8.8</p>	<p>120 0267</p> <p>120 0266 120 7059</p>	<p>3,70 kg</p> <p>3,30 kg 0,36 kg</p>
	<p>Dent de Ressort 45 x 10 avec soc 40 x 6 x 215 droit comme KW111099018 assemblé de: Dent 45 x 10 droit Soc 40 x 6 x 215 droit et boulon de soc M10 x 45 / 8.8</p>	<p>120 0267</p> <p>120 0266 120 7059</p>	<p>3,70 kg</p> <p>3,30 kg 0,36 kg</p>

Federzinken, gerade // Spring Tines, straight // Dents de Ressort, droit

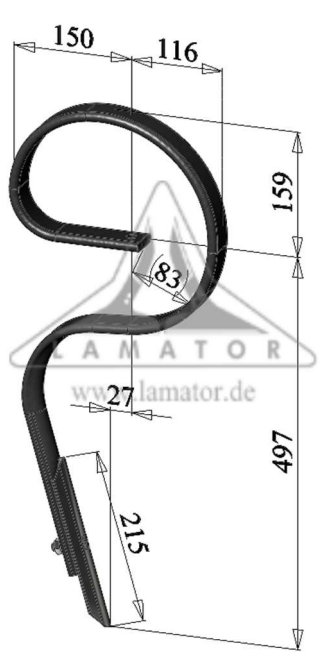
	Artikelbezeichnung Description // Dénomination	Artikel-Nr. Part Number le code article	Gewicht weight // poids
	<p>❖ Federzinken 45 x 12 für Einbauhöhe 500 mm mit Schar 40 x 6 x 215 bestehend aus: Zinken 45 x 12 gerade Wendeschar 40 x 6 x 215 gerade und Planetschraube M10 x 45 / 8.8</p>	<p>120 9155</p> <p>120 9154 120 7059</p>	<p>4,81 kg</p> <p>4,41 kg 0,36 kg</p>
	<p>Spring Tine 45 x 12 installation height 500 mm with point 40 x 6 x 215 straight consist of: Tine 45 x 12 straight R-point 40 x 6 x 215 straight and cultivator bolt M10 x 45 / 8.8</p>	<p>120 9155</p> <p>120 9154 120 7059</p>	<p>4,81 kg</p> <p>4,41 kg 0,36 kg</p>
	<p>Dent de Ressort 45 x 12 pour hauteur de montage de 500 mm avec soc 40 x 6 x 215 droit assemblé de: Dent 45 x 12 droit soc 40 x 6 x 215 droit et boulon de soc M10 x 45 / 8.8</p>	<p>120 9155</p> <p>120 9154 120 7059</p>	<p>4,81 kg</p> <p>4,41 kg 0,36 kg</p>
	<p>Passende Überfeder 45 x 10 Fitting Helper Spring 45 x 10 Ressort Subsidiaire approprié 45 x 10</p>	<p>120 9138</p>	<p>2,57 kg</p>

Überfedern // Helper Springs // Ressorts Subsidiaries

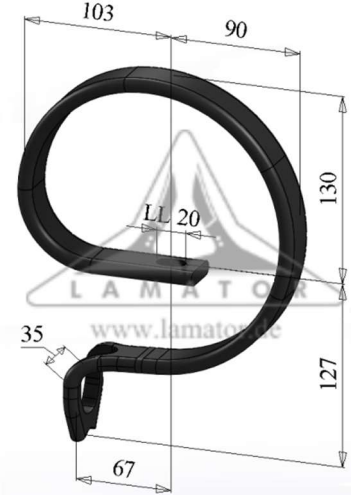
	Artikelbezeichnung Description // Dénomination	Artikel-Nr. Part Number le code article	Gewicht weight // poid
	<p>❖ Überfeder mit Öse 32 x 10 Kopfverstärkung für die Standard-, Kulti- und Spezialzinken mit einem Querschnitt von 32 x 10 und 32 x 12 passend zu den Artikelnummern 120 9130 / 9131 120 8902 / 9011 120 8935 / 9028 120 3250 / 0250 120 0037 / 0137 120 0044 / 0144 120 8945</p>	<p>120 9135</p>	<p>1,57 kg</p>
	<p>Helper Spring with eye 32 x 10 Strengthening for Standard, Kulti and Special Tines with a section of 32 x 10 and 32 x 12 Fitting to the part-numbers: 120 9130 / 9131 120 8902 / 9011 120 8935 / 9028 120 3250 / 0250 120 0037 / 0137 120 0044 / 0144 120 8945</p>	<p>120 9135</p>	<p>1,57 kg</p>
	<p>Ressort Subsidiaire avec boucle 32 x 10 Renforcement de tête pour Dents Standard, Kulti et Spécials d'une coupe transversale de 32 x 10 et 32 x 12 Approprié aux Réf. LAMATOR: 120 9130 / 9131 120 8902 / 9011 120 8935 / 9028 120 3250 / 0250 120 0037 / 0137 120 0044 / 0144 120 8945</p>	<p>120 9135</p>	<p>1,57 kg</p>

Überfedern // Helper Springs // Ressorts Subsidiaries

	Artikelbezeichnung Description // Dénomination	Artikel-Nr. Part Number le code article	Gewicht weight // poids
	<p>❖ Überfeder mit Öse 45 x 10 Kopfverstärkung für die Groß- zinken mit einem Querschnitt von 45 x 12 passend zu den Artikelnummern 120 8251 120 8252 120 8381 / 8382 / 8383 120 8280 120 9124 / 9125 120 9154 / 9155</p> <p>Helper Spring with eye 45 x 10 Strengthening for Extra Heavy Tines with a section of 45 x 12 Fitting to the part-numbers: 120 8251 120 8252 120 8381 / 8382 / 8383 120 8280 120 9124 / 9125 120 9154 / 9155</p>	<p>120 9138</p> <p>120 9138</p>	<p>2,57 kg</p> <p>2,57 kg</p>
	<p>Ressort Subsidiaire avec boucle 45 x 10 Renforcement de tête pour Dents Forts d'une section transversale de 45 x 12 Approprié aux Réf. LAMATOR: 120 8251 120 8252 120 8381 / 8382 / 8383 120 8280 120 9124 / 9125 120 9154 / 9155</p>	<p>120 9138</p>	<p>2,57 kg</p>

Überfedern // Helper Springs // Ressorts Subsidiaries

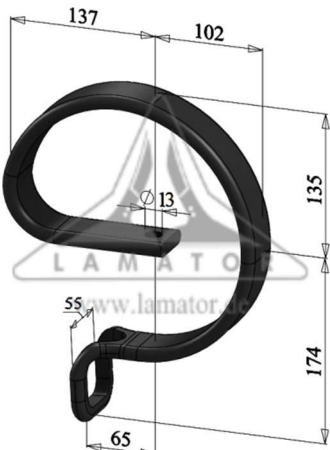
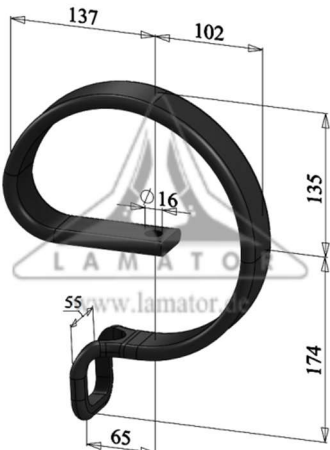
	Artikelbezeichnung Description // Dénomination	Artikel-Nr. Part Number le code article	Gewicht weight // poids
	<p>❖ Überfeder mit Öse 50 x 13 mit Bohrung Ø 13 Kopfverstärkung für die Großzinken mit einem Querschnitt von 50 x 13 passend zur Artikelnummer 120 9350 / 9351</p> <p>Helper Spring with eye 50 x 13 with Ø 13 Strengthening for Extra Heavy Tines with a section of 50 x 13 Fitting to the part-number: 120 9350 / 9351</p> <p>Ressort Subsidiaire avec boucle 50 x 13 with Ø 13 Renforcement de tête pour Dents Forts d'une section transversale de 50 x 13 Approprié aux Réf. LAMATOR: 120 9350 / 9351</p>	<p>120 9352</p> <p>120 9352</p> <p>120 9352</p>	<p>3,72 kg</p> <p>3,72 kg</p> <p>3,72 kg</p>
	<p>❖ Überfeder mit Öse 50 x 13 mit Bohrung Ø 16 Kopfverstärkung für die Großzinken mit einem Querschnitt von 50 x 13 passend zur Artikelnummer 120 9350 1 / 9351 1</p> <p>Helper Spring with eye 50 x 13 with Ø 16 Strengthening for Extra Heavy Tines with a section of 50 x 13 Fitting to the part-number: 120 9350 1 / 9351 1</p> <p>Ressort Subsidiaire avec boucle 50 x 13 avec Ø 16 Renforcement de tête pour Dents Forts d'une section transversale de 50 x 13 Approprié aux Réf. LAMATOR: 120 9350 1 / 9351 1</p>	<p>120 9352 1</p> <p>120 9352 1</p> <p>120 9352 1</p>	<p>3,72 kg</p> <p>3,72 kg</p> <p>3,72 kg</p>

Überfedern // Helper Springs // Ressorts Subsidiaries

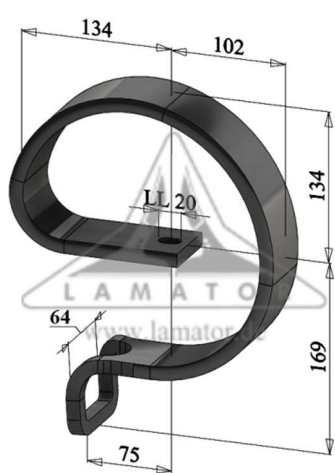

	Artikelbezeichnung Description // Dénomination	Artikel-Nr. Part Number le code article	Gewicht weight // poid
	<p>❖ Überfeder mit Öse 60 x 12 Kopfverstärkung für die Groß- zinken mit einem Querschnitt von 60 x 12 passend zu der Artikelnummer 120 9361</p> <p>Helper Spring with eye 60 x 12 Strengthening for Extra Heavy Tines with a section of 60 x 12 Fitting to the part-number: 120 9361</p> <p>Ressort Subsidiaire avec boucle 60 x 12 Renforcement de tête pour Dents Forts d'une section transversale de 60 x 12 Approprié aux Réf. LAMATOR: 120 9361</p>	<p>120 9362</p> <p>120 9362</p> <p>120 9362</p>	<p>4,24 kg</p> <p>4,24 kg</p> <p>4,24 kg</p>

Sonderzinken // Special Tines // Dents Spéciaux

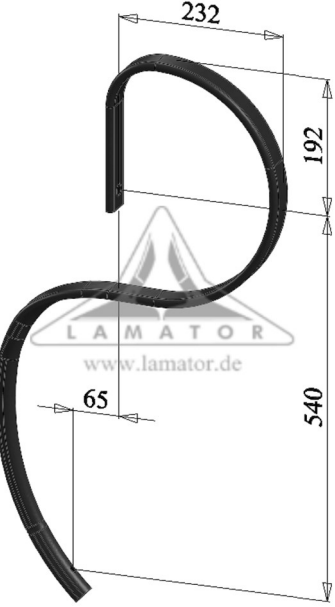

	Artikelbezeichnung Description // Dénomination	Artikel-Nr. Part Number le code article	Gewicht weight // poids
	❖ Großzinken 45 x 12 gerade, ohne Schar	120 8280	5,38 kg
	Extra Heavy Tine 45 x 12 straight, without point	120 8280	5,38 kg
	Dent Fort 45 x 12 droit, sans soc	120 8280	5,38 kg
	Passende Überfeder 45 x 10 Fitting Helper Spring 45 x 10 Ressort Subsidiaire approprié 45 x 10	120 9138	2,57 kg

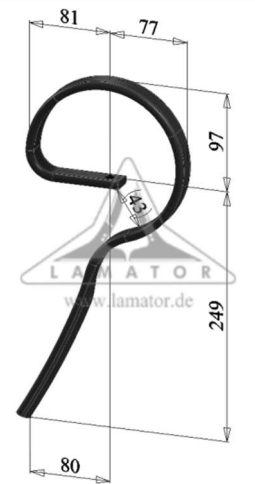
	❖ Sonderzinken 45 x 12 x 775 ohne Schar	120 9150	5,22 kg
	Special Tine 45 x 12 x 775 without point	120 9150	5,22 kg
	Dent Spécial 45 x 12 x 775 sans soc	120 9150	5,22 kg

Gareeggen-Zinken // Harrow Tines // Dents herse Vibrantes

	Artikelbezeichnung Description // Dénomination	Artikel-Nr. Part Number le code article	Gewicht weight // poids
	<p>❖ Gareeggen-Zinken 25 x 8 kurz, gebogen</p> <p>Harrow Tine 25 x 8 short, bent</p> <p>Dent herse Vibrante 25 x 8 court, plié</p>	<p>120 8814</p> <p>120 8814</p> <p>120 8814</p>	<p>1,03 kg</p> <p>1,03 kg</p> <p>1,03 kg</p>
	<p>❖ Gareeggen-Zinken 25 x 8 kurz, gerade, vorn</p> <p>Harrow Tine 25 x 8 short, straight, in front</p> <p>Dent herse Vibrante 25 x 8 court, droit, 1e rang</p>	<p>120 8847</p> <p>120 8847</p> <p>120 8847</p>	<p>0,90 kg</p> <p>0,90 kg</p> <p>0,90 kg</p>
	<p>❖ Gareeggen-Zinken 25 x 8 mit Schar 30 x 5 x 170 mit Schar 40 x 6 x 135 und Planetschraube M10 x 35 / 8.8</p> <p>Harrow Tine 25 x 8 with point 30 x 5 x 170 with point 40 x 6 x 135 and cultivator bolt M10 x 35 / 8.8</p> <p>Dent herse Vibrante 25 x 8 avec soc 30 x 5 x 170 avec soc 40 x 6 x 135 et boulon de soc M10 x 35 / 8.8</p>	<p>120 8461</p> <p>120 8462</p> <p>120 8461</p> <p>120 8462</p> <p>120 8461</p> <p>120 8462</p>	<p>1,24 kg</p> <p>1,27 kg</p> <p>1,24 kg</p> <p>1,27 kg</p> <p>1,24 kg</p> <p>1,27 kg</p>

Gareeggen-Zinken // Harrow Tines // Dents herse Vibrantes

	Artikelbezeichnung Description // Dénomination	Artikel-Nr. Part Number le code article	Gewicht weight // poids
	<p>❖ Gareeggen-Zinken 25 x 8 lang, gebogen</p> <p>Harrow Tine 25 x 8 long, bent</p> <p>Dent herse Vibrante 25 x 8 longue, plié</p>	<p>120 8822</p> <p>120 8822</p> <p>120 8822</p>	<p>1,08 kg</p> <p>1,08 kg</p> <p>1,08 kg</p>
	<p>❖ Gareeggen-Zinken 25 x 8 lang, gerade, vorn</p> <p>Harrow Tine 25 x 8 long, straight, in front</p> <p>Dent herse Vibrante 25 x 8 longue, droit, 1e rang</p>	<p>120 8830</p> <p>120 8830</p> <p>120 8830</p>	<p>0,94 kg</p> <p>0,94 kg</p> <p>0,94 kg</p>

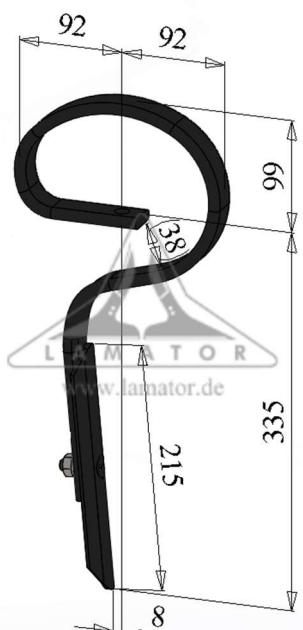

Gareeggen-Zinken // Harrow Tines // Dents herse Vibrantes

	Artikelbezeichnung Description // Dénomination	Artikel-Nr. Part Number le code article	Gewicht weight // poid
	❖ Gareeggen-Kompakt-Zinken 32 x 10 Germinator mit Schar 40 x 6 x 135 gerade und Planetschraube M10 x 37 / 8.8	120 8480	1,88 kg
	Harrow Compact Tine 32 x 10 Germinator with point straight 40 x 6 x 135 and cultivator bolt M10 x 37 / 8.8	120 8480	1,88 kg
	Dent herse Vibrante Compact 32 x 10 Germinator	120 8480	1,88 kg
	avec soc 40 x 6 x 135 droit et boulon de soc M10 x 37 / 8.8	120 7058	0,21 kg
	❖ Gareeggen-Kompakt-Zinken 32 x 10 Germinator mit Schar 40 x 6 x 215 gerade und Planetschraube M10 x 37 / 8.8	120 8482	2,03 kg
	Harrow Compact Tine 32 x 10 Germinator with point straight 40 x 6 x 215 and cultivator bolt M10 x 37 / 8.8	120 8482	2,03 kg
	Dent herse Vibrante Compact 32 x 10 Germinator	120 8482	2,03 kg
	avec soc 40 x 6 x 215 droit et boulon de soc M10 x 37 / 8.8	120 7059	0,36 kg

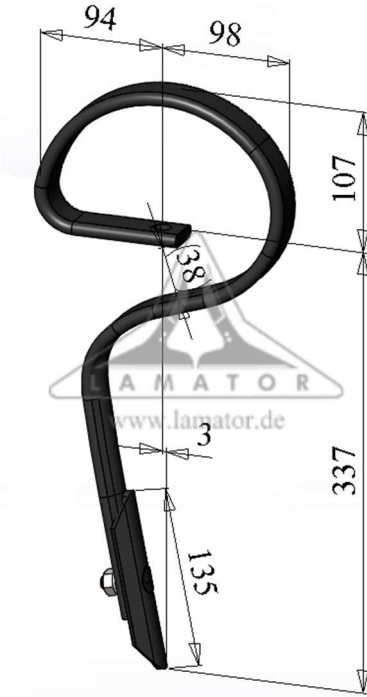
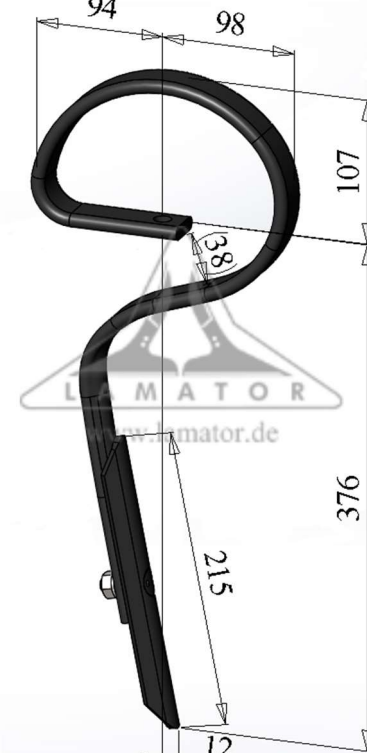
Gareeggen-Zinken // Harrow Tines // Dents herse Vibrantes

	Artikelbezeichnung Description // Dénomination	Artikel-Nr. Part Number le code article	Gewicht weight // poids
	❖ Gareeggen-Kompakt-Zinken 32 x 10, lang <i>Germinator lang</i> mit Schar 40 x 6 x 135 gerade und Planetschraube M10 x 37 / 8.8	120 8490	2,03 kg
	Harrow Compact Tine 32 x 10, long <i>Germinator long</i>	120 8490	2,03 kg
	with point straight 40 x 6 x 135 and cultivator bolt M10 x 37 / 8.8	120 7058	0,21 kg
	Dent herse Vibrante Compact 32 x 10, longue <i>Germinator longue</i>	120 8490	2,03 kg
	❖ Gareeggen-Kompakt-Zinken 32 x 10, lang <i>Germinator lang</i> mit Schar 40 x 6 x 215 gerade und Planetschraube M10 x 37 / 8.8	120 8492	2,19 kg
	Harrow Compact Tine 32 x 10, long <i>Germinator long</i>	120 8492	2,19 kg
	with point straight 40 x 6 x 215 and cultivator bolt M10 x 37 / 8.8	120 7059	0,36 kg
	Dent herse Vibrante Compact 32 x 10, longue <i>Germinator longue</i>	120 8492	2,19 kg
avec soc 40 x 6 x 215 droit et boulon de soc M10 x 37 / 8.8	120 7059	0,36 kg	

Gareeggen-Zinken // Harrow Tines // Dents herse Vibrantes

	Artikelbezeichnung Description // Dénomination	Artikel-Nr. Part Number le code article	Gewicht weight // poid
	<p>❖ Gareeggen-Zinken 25 x 8 RAU gebogen</p> <p>Harrow Tine 25 x 8 RAU bent</p> <p>Dent herse Vibrante 25 x 8 RAU plié</p>	<p>120 8471</p> <p>120 8471</p> <p>120 8471</p>	<p>0,99 kg</p> <p>0,99 kg</p> <p>0,99 kg</p>
	<p>❖ Gareeggen-Zinken 25 x 8 RAU gerade, vorn</p> <p>Harrow Tine 25 x 8 RAU straight, in front</p> <p>Dent herse Vibrante 25 x 8 RAU droit, 1e rang</p>	<p>120 8472</p> <p>120 8472</p> <p>120 8472</p>	<p>0,89 kg</p> <p>0,89 kg</p> <p>0,89 kg</p>
	<p>❖ Gareeggen-Zinken 25 x 8 RAU mit Schar 25 x 5 x 140 und Planetschraube M8 x 33 / 8.8</p> <p>Harrow Tine 25 x 8 RAU with point 25 x 5 x 140 and cultivator bolt M8 x 33 / 8.8</p> <p>Dent herse Vibrante 25 x 8 RAU avec soc 25 x 5 x 140 et boulon de soc M8 x 33 / 8.8</p>	<p>120 8470</p> <p>120 8485</p> <p>120 8470</p> <p>120 8485</p> <p>120 8470</p> <p>120 8485</p>	<p>1,08 kg</p> <p>0,13 kg</p> <p>1,08 kg</p> <p>0,13 kg</p> <p>1,08 kg</p> <p>0,13 kg</p>

Spurlockerer // Track Eradicator // Efface-Traces

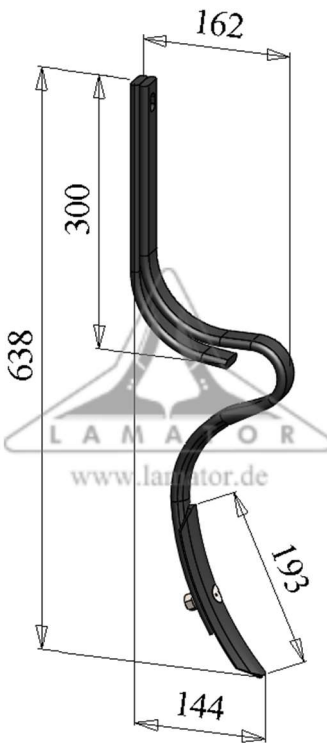
	Artikelbezeichnung Description // Dénomination	Artikel-Nr. Part Number le code article	Gewicht weight // poids
	❖ Spurlockerer 32 x 10, kurz zusammengesetzt aus: Zinken Spurlockerer 32 x 10 Überfeder 32 x 10 Schar 40 x 6 x 200 und Planetschraube M10 x 37 / 8.8	120 9614 120 9621 120 9430 120 5555	2,91 kg 1,72 kg 0,82 kg 0,33 kg
	Zinken Spurlockerer 32 x 10 mit Schar 40 x 6 x 200	120 9622	2,09 kg
	Track Eradicator 32 x 10, short consist of: Track Eradicator Tine 32 x 10 Helper Spring 32 x 10 point 40 x 6 x 200 and cultivator bolt M10 x 37 / 8.8	120 9614 120 9621 120 9430 120 5555	2,91 kg 1,72 kg 0,82 kg 0,33 kg
	Track Eradicator Tine 32 x 10 with point 40 x 6 x 200	120 9622	2,09 kg
	Efface-Trace 32 x 10, court assemblé de: Dent Efface-Trace 32 x 10 Ressort Subsidiaire 32 x 10 soc 40 x 6 x 200 et boulon de soc M10 x 37 / 8.8	120 9614 120 9621 120 9430 120 5555	2,91 kg 1,72 kg 0,82 kg 0,33 kg
	Dent Efface-Trace 32 x 10 avec soc 40 x 6 x 200	120 9622	2,09 kg

Spurlockerer // Track Eradicator // Efface-Traces

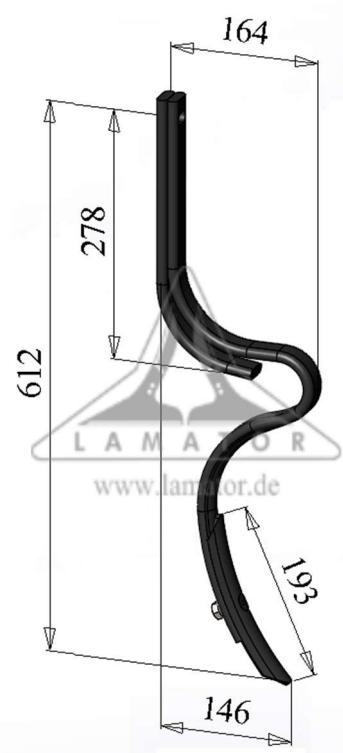
	Artikelbezeichnung Description // Dénomination	Artikel-Nr. Part Number le code article	Gewicht weight // poids
	<p>❖ Spurlockerer 32 x 12, kurz zusammengesetzt aus: Zinken Spurlockerer 32 x 12 Überfeder 32 x 12 Schar 40 x 6 x 200 und Planetschraube M10 x 37 / 8.8</p>	<p>120 9614 1</p>	<p>3,26 kg</p>
	<p>Zinken Spurlockerer 32 x 12 mit Schar 40 x 6 x 200</p>	<p>120 9622 1</p>	<p>2,32 kg</p>
	<p>Track Eradicator 32 x 12, short consist of: Track Eradicator Tine 32 x 12 Helper Spring 32 x 12 point 40 x 6 x 200 and cultivator bolt M10 x 37 / 8.8</p>	<p>120 9614 1</p>	<p>3,26 kg</p>
	<p>Track Eradicator Tine 32 x 12 with point 40 x 6 x 200</p>	<p>120 9622 1</p>	<p>2,32 kg</p>
	<p>Efface-Trace 32 x 12, court assemblé de: Dent Efface-Trace 32 x 12 Ressort Subsidiaire 32 x 12 soc 40 x 6 x 200, et boulon de soc M10 x 37 / 8.8</p>	<p>120 9614 1</p>	<p>3,26 kg</p>
	<p>Dent Efface-Trace 32 x 12 avec soc 40 x 6 x 200</p>	<p>120 9622 1</p>	<p>2,32 kg</p>

Spurlockerer // Track Eradicators // Efface-Traces

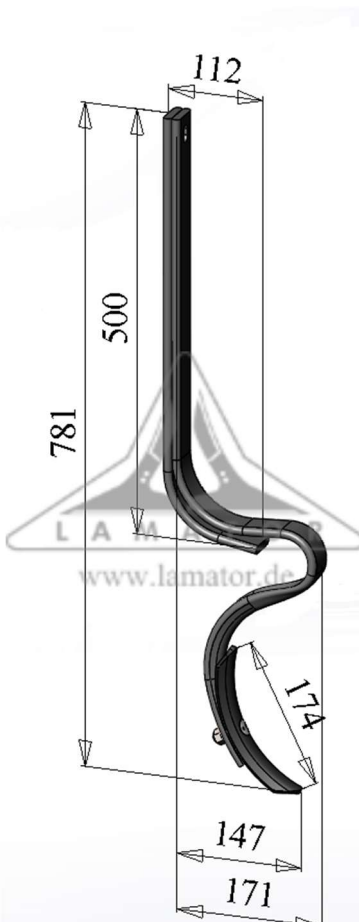
	Artikelbezeichnung Description // Dénomination	Artikel-Nr. Part Number le code article	Gewicht weight // poids
	<p>❖ Spurlockerer 40 x 10, lang zusammengesetzt aus: Zinken Spurlockerer 40 x 10 Überfeder 40 x 10 Schar 40 x 6 x 199 und Planetschraube M10 x 40 / 8.8</p>	<p>120 9542</p>	<p>4,56 kg</p>
	<p>Zinken Spurlockerer 40 x 10 mit Schar 40 x 6 x 199</p>	<p>120 9550</p>	<p>2,96 kg</p>
	<p>Track Eradicator 40 x 10, long consist of: Track Eradicator Tine 40 x 10 Helper Spring 40 x 10 point 40 x 6 x 199 and cultivator bolt M10 x 40 / 8.8</p>	<p>120 9542</p>	<p>4,56 kg</p>
	<p>Track Eradicator Tine 40 x 10 with point 40 x 6 x 199</p>	<p>120 9550</p>	<p>2,96 kg</p>
	<p>Efface-Trace 40 x 10, longue assemblé de: Dent Efface-Trace 40 x 10 Ressort Subsidiaire 40 x 10 soc 40 x 6 x 199 et boulon de soc M10 x 40 / 8.8</p>	<p>120 9542</p>	<p>4,56 kg</p>
	<p>Dent Efface-Trace 40 x 10 avec soc 40 x 6 x 199</p>	<p>120 9550</p>	<p>2,96 kg</p>

Schleppzinken (Nivellierzinken) // Levelling Tines // Dents Nivelants

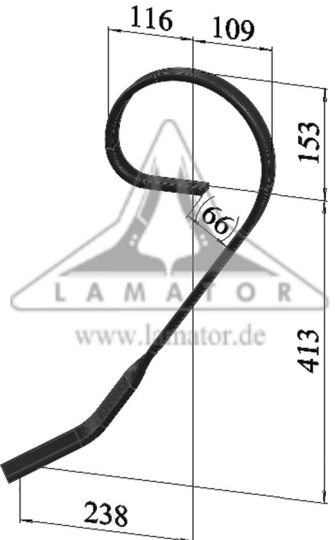
	Artikelbezeichnung Description // Dénomination	Artikel-Nr. Part Number le code article	Gewicht weight // poids
	❖ Schleppzinken 32 x 10 links	120 9591	2,44 kg
	Levelling Tine 32 x 10 left	120 9591	2,44 kg
	Dent Nivelant 32 x 10 gauche	120 9591	2,44 kg
	❖ Schleppzinken 45 x 12 links	120 9592	4,00 kg
	Levelling Tine 45 x 12 left	120 9592	4,00 kg
	Dent Nivelant 45 x 12 gauche	120 9592	4,00 kg
	❖ Schleppzinken 32 x 10 rechts	120 9606	2,44 kg
	Levelling Tine 32 x 10 right	120 9606	2,44 kg
	Dent Nivelant 32 x 10 droite	120 9606	2,44 kg
	❖ Schleppzinken 45 x 12 rechts	120 9607	4,00 kg
	Levelling Tine 45 x 12 right	120 9607	4,00 kg
	Dent Nivelant 45 x 12 droite	120 9607	4,00 kg

Schleppzinken und Zubehör // Levelling Tines and Accessories // Dents Nivelants et Attirail

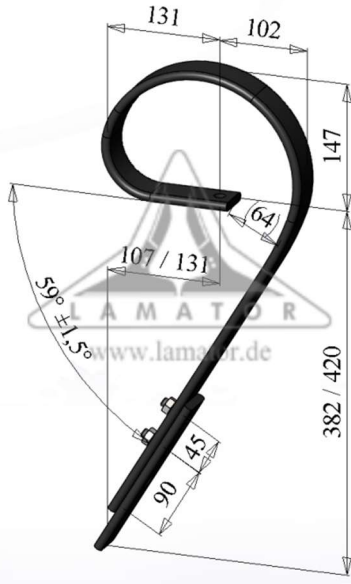
	Artikelbezeichnung Description // Dénomination	Artikel-Nr. Part Number le code article	Gewicht weight // poid
	<p>❖ Schleppzinken 45 x 10 ohne Verschleißplatte</p> <p>Levelling Tine 45 x 10 without Wearing Plate</p> <p>Dent Nivelant 45 x 10 sans Pièce d'usure</p>	<p>120 8013</p> <p>120 8013</p> <p>120 8013</p>	<p>3,01 kg</p> <p>3,01 kg</p> <p>3,01 kg</p>
	<p>❖ Schleppzinken 45 x 10, 2-Loch, mit Verschleißplatte <i>Horsch 00310092</i> bestehend aus: Schleppzinken 45 x 10, 2-Loch, mit Verschleißplatte 45 x 10 gerade und zwei Schrauben</p> <p>Levelling Tine 45 x 10, 2-holes with Wearing Plate <i>Horsch 00310092</i> consist of: Levelling Tine 45 x 10, 2 holes Wearing Plate 45 x 10 straight and two bolts</p> <p>Dent Nivelant 45 x 10, 2 trous avec Pièce d'usure <i>Horsch 00310092</i> assemblé de: Dent Nivelant 45 x 10, 2 trous Pièce d'usure 45 x 10 droit et deux boulons</p>	<p>120 8111 1</p> <p>120 8110 120 8014 1</p> <p>120 8111 1</p> <p>120 8110 120 8014 1</p> <p>120 8111 1</p> <p>120 8110 120 8014 1</p>	<p>3,82 kg</p> <p>3,05 kg 0,65 kg</p> <p>3,82 kg</p> <p>3,05 kg 0,65 kg</p> <p>3,82 kg</p> <p>3,05 kg 0,65 kg</p>

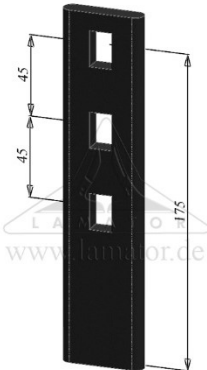
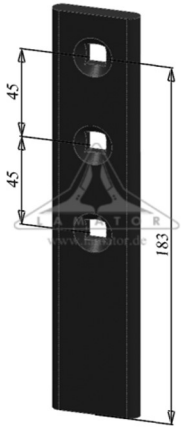
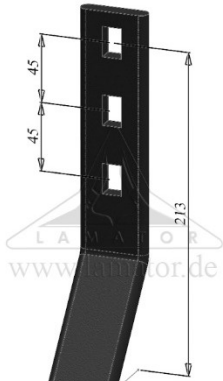

Verschleißteile // Wearing Parts // Pièces d'usure

	Artikelbezeichnung Description // Dénomination	Artikel-Nr. Part Number le code article	Gewicht weight // poids
	<p>❖ Verschleißplatte 45 x 10, gerade <i>Original-Nr. 419998-1 / 416256</i></p> <p>Wearing Plate 45 x 10, straight <i>original no. 419998-1 / 416256</i></p> <p>Pièce d'usure 45 x 10, droit <i>original no. 419998-1 / 416256</i></p>	<p>120 8014</p> <p>120 8014</p> <p>120 8014</p>	<p>0,62 kg</p> <p>0,62 kg</p> <p>0,62 kg</p>
	<p>❖ Verschleißplatte 45 x 10, gerade mit 3 x 4-kant Lochung / Senkung <i>Original-Nr. 00310092</i></p> <p>Wearing plate 45 x 10, straight with 3 x 4-square hole countersunk <i>original no. 00310092</i></p> <p>Pièce d'usure 45 x 10, droit avec 3 trous carrés lamés <i>original no. 00310092</i></p>	<p>120 8014 1</p> <p>120 8014 1</p> <p>120 8014 1</p>	<p>0,65 kg</p> <p>0,65 kg</p> <p>0,65 kg</p>
	<p>❖ Verschleißplatte 45 x 10, gekantet <i>Original-Nr. 419997-1 / 415409</i></p> <p>Wearing Plate 45 x 10, bent <i>original no. 419997-1 / 415409</i></p> <p>Pièce d'usure 45 x 10, coudé <i>original no. 419997-1 / 415409</i></p>	<p>120 8015</p> <p>120 8015</p> <p>120 8015</p>	<p>0,80 kg</p> <p>0,80 kg</p> <p>0,80 kg</p>

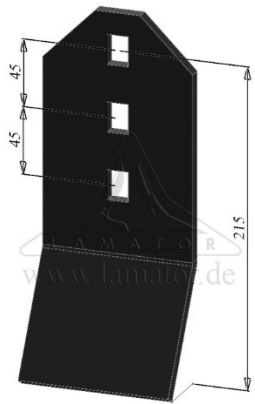
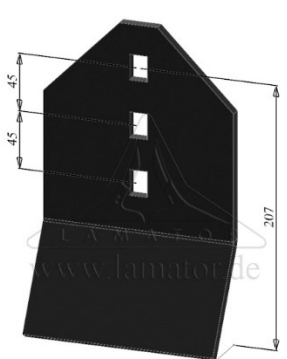
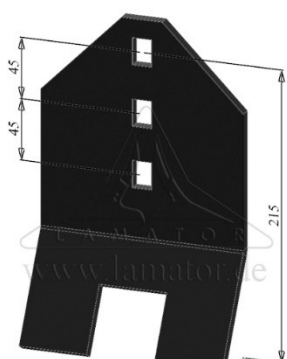

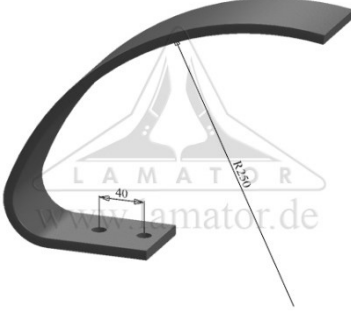
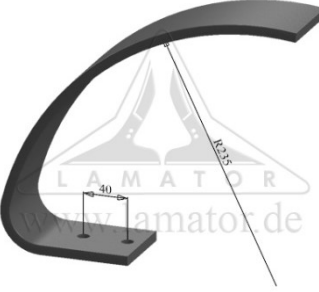

Verschleißteile // Wearing Parts // Pièces d'usure

	Artikelbezeichnung Description // Dénomination	Artikel-Nr. Part Number le code article	Gewicht weight // poids
	❖ Verschleißplatte 100 x 8, gekantet <i>Original-Nr. 419999-1 / 415872</i>	120 8016	1,47 kg
	Wearing plate 100 x 8, bent <i>original no. 419999-1 / 415872</i>	120 8016	1,47 kg
	Pièce d'usure 100 x 8, coudé <i>original no. 419999-1 / 415872</i>	120 8016	1,47 kg
	❖ Verschleißplatte 150 x 8, gekantet <i>Original-Nr. 420330 / 440603-1</i>	120 8017	2,20 kg
	Wearing plate 150 x 8, bent <i>original no. 420330 / 440603-1</i>	120 8017	2,20 kg
	Pièce d'usure 150 x 8, coudé <i>original no. 420330 / 440603-1</i>	120 8017	2,20 kg
	❖ Verschleißplatte 150 x 8, gekantet und ausgeklinkt	120 8018	1,94 kg
	Wearing plate 150 x 8 bent and notched	120 8018	1,94 kg
	Pièce d'usure 150 x 8 coudé et grugé	120 8018	1,94 kg

Packer- und Packerzwischenfedern // Packer Springs and Intermediate Packer Springs // Ressorts Packer et Ressorts Packer intermédiaire

	Artikelbezeichnung Description // Dénomination	Artikel-Nr. Part Number le code article	Gewicht weight // poids
	❖ Packerfeder 60 x 9 RollFlex-Walze <i>Horsch 00330141</i>	120 9710	2,00 kg
	Packer Spring 60 x 9 RollFlex Roller <i>Horsch 00330141</i>	120 9710	2,00 kg
	Ressort Packer 60 x 9 Rouleau RollFlex <i>Horsch 00330141</i>	120 9710	2,00 kg
	❖ Packerfeder 70 x 9 RollFlex-Walze <i>Horsch 00330142</i>	120 9714	2,23 kg
	Packer Spring 70 x 9 RollFlex Roller <i>Horsch 00330142</i>	120 9714	2,23 kg
	Ressort Packer 70 x 9 Rouleau RollFlex <i>Horsch 00330142</i>	120 9714	2,23 kg
	❖ Packerfeder 70 x 10 RollFlex-Walze <i>Horsch 00330198</i>	120 9708	3,00 kg
	Packer Spring 70 x 10 RollFlex Roller <i>Horsch 00330198</i>	120 9708	3,00 kg
	Ressort Packer 70 x 10 Rouleau RollFlex <i>Horsch 00330198</i>	120 9708	3,00 kg

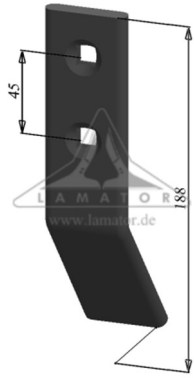
Packer- und Packerzwischenfedern // Packer Springs and Intermediate Packer Springs // Ressorts Packer et Ressorts Packer intermédiaire

	Artikelbezeichnung Description // Dénomination	Artikel-Nr. Part Number le code article	Gewicht weight // poids
	<p>❖ Packerzwischenfeder 60 x 9 Einlochausführung <i>RollFlex-Walze Horsch 34283704</i></p> <p>Intermediate Packer Spring 60 x 9 1 hole <i>RollFlex Roller Horsch 34283704</i></p> <p>Ressort Packer intermédiaire 60 x 9 1 trou <i>Rouleau RollFlex Horsch 34283704</i></p>	<p>120 9711</p> <p>120 9711</p> <p>120 9711</p>	<p>3,27 kg</p> <p>3,27 kg</p> <p>3,27 kg</p>
	<p>❖ Packerzwischenfeder 60 x 9 Zweilochausführung <i>Horsch 00330109</i></p> <p>Intermediate Packer Spring 60 x 9 2 holes <i>Horsch 00330109</i></p> <p>Ressort Packer intermédiaire 60 x 9 2 trous <i>Horsch 00330109</i></p>	<p>120 9712</p> <p>120 9712</p> <p>120 9712</p>	<p>3,27 kg</p> <p>3,27 kg</p> <p>3,27 kg</p>
	<p>❖ Verschleißplatte 45 x 10 für Packerzwischenfeder 60 x 9 <i>Horsch 34265006</i></p> <p>Wearing plate 45 x 10 for Intermediate Packer Spring 60 x 9 <i>Horsch 34265006</i></p> <p>Pièce d'usure 45 x 10 pour Ressort Packer intermédiaire 60 x 9 <i>Horsch 34265006</i></p>	<p>120 8019</p> <p>120 8019</p> <p>120 8019</p>	<p>0,65 kg</p> <p>0,65 kg</p> <p>0,65 kg</p>
	<p>❖ Striegelblattfeder 50 x 6 für Drillmaschine PRONTO <i>Horsch 23250301</i></p> <p>Harrow spring 50 x 6 for seeding machine PRONTO <i>Horsch 23250301</i></p> <p>Ressort 50 x 6 pour étrille sémoir PRONTO <i>Horsch 23250301</i></p>	<p>120 9713</p> <p>120 9713</p> <p>120 9713</p>	<p>1,79 kg</p> <p>1,79 kg</p> <p>1,79 kg</p>

Schneide // Knife // Couteau

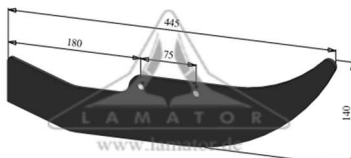
	Artikelbezeichnung Description // Dénomination	Artikel-Nr. Part Number le code article	Gewicht weight // poid
	❖ Schneide für Rollcut <i>Horsch 34286011</i>	120 9702	1,41 kg
	Knife for Rollcut <i>Horsch 34286011</i>	120 9702	1,41 kg
	Couteau pour Rollcut <i>Horsch 34286011</i>	120 9702	1,41 kg
<p>passend für Terrano FX, Joker CT (ab Baujahr 2008)</p>			

Federzinken Steinsammler // Spring Tine for Stone Picker // Dent de ramasseuse de pierres

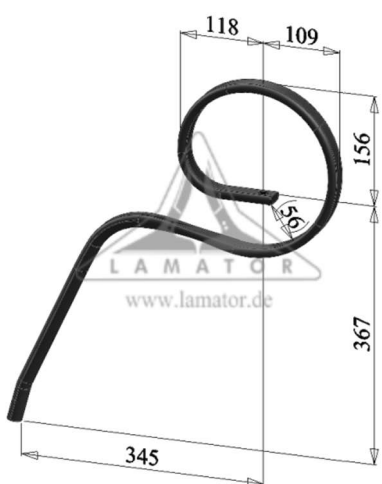
	Artikelbezeichnung Description // Dénomination	Artikel-Nr. Part Number le code article	Gewicht weight // poid
	❖ Steinsammler-Zinken 32 x 12 für <i>Kongskilde Stonebear</i> <i>Kongskilde 500068401</i>	120 8945a	3,18 kg
	Stone Picker Tine 32 x 12 for <i>Kongskilde Stonebear</i> <i>Kongskilde 500068401</i>	120 8945a	3,18 kg
	Dent de ramasseuse de pierres 32 x 12 pour <i>Kongskilde Stonebear</i> <i>Kongskilde 500068401</i>	120 8945a	3,18 kg
	Passende Überfeder 32 x 10 <i>Kongskilde 500068402</i> Fitting Helper Spring 32 x 10 <i>Kongskilde 500068402</i> Ressort Subsidaire approprié 32 x 10 <i>Kongskilde 500068402</i>	120 9135	1,57 kg

Zinkenfedern // Special Springs // Ressorts Spéciaux

	Artikelbezeichnung Description // Dénomination	Artikel-Nr. Part Number le code article	Gewicht weight // poid
	❖ Zinkenfeder 32 x 10 Ende verdreht	120 9670	1,57 kg
	Spring 32 x 10 twisted end	120 9670	1,57 kg
	Ressort 32 x 10 bout tordue	120 9670	1,57 kg

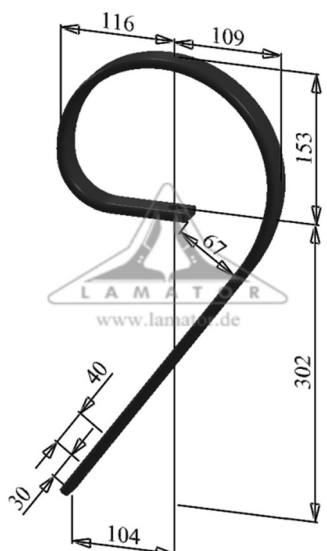
	❖ Zinkenfeder 32 x 10	120 8010	2,06 kg
	Spring 32 x 10	120 8010	2,06 kg
	Ressort 32 x 10	120 8010	2,06 kg

Zinkenfedern // Special Springs // Ressorts Spéciaux

Artikelbezeichnung Description // Dénomination	Artikel-Nr. Part Number le code article	Gewicht weight // poid
---	---	---------------------------



❖ **Zinkenfeder 45 x 12**
lang

120 8011

3,35 kg

Spring 45 x 12
long

120 8011

3,35 kg

Ressort 45 x 12
Longue

120 8011

3,35 kg



❖ **Zinkenfeder 45 x 12**
kurz

120 8012

2,77 kg

Spring 45 x 12
short

120 8012

2,77 kg

Ressort 45 x 12
court

120 8012

2,77 kg

Spezialfedern // Special Springs // Ressorts Spéciaux

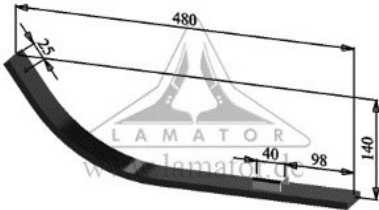
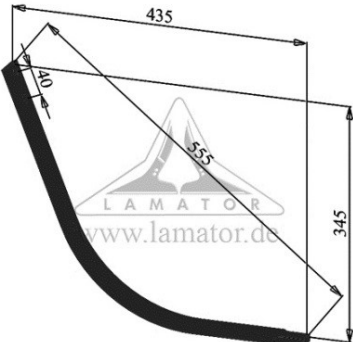
	Artikelbezeichnung Description // Dénomination	Artikel-Nr. Part Number le code article	Gewicht weight // poid
	❖ Abstreifer 50 x 10 <i>Köckerling 633238</i>	120 9570	2,19 kg
	Scraper 50 x 10 <i>Köckerling 633238</i>	120 9570	2,19 kg
	Défecteur 50 x 10 <i>Köckerling 633238</i>	120 9570	2,19 kg
	❖ Zwischenfeder 45 x 10 <i>Köckerling 904478</i>	120 9571	2,01 kg
	Intermediate Spring 45 x 10 <i>Köckerling 904478</i>	120 9571	2,01 kg
	Ressort intermédiaire 45 x 10 <i>Köckerling 904478</i>	120 9571	2,01 kg

Hacktechnik // Hoe parts // Outils de bineuse

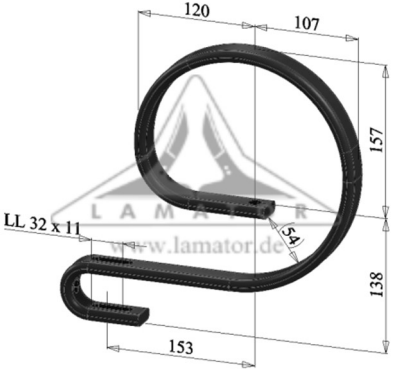
	Artikelbezeichnung Description // Dénomination	Artikel-Nr. Part Number le code article	Gewicht weight // poids
	❖ Universal-Vibrofeder 32 x 12	120 4101	2,61 kg
	Vibro Spring 32 x 12	120 4101	2,61 kg
	Ressort vibrant 32 x 12	120 4101	2,61 kg

Rechenzinken // Rake Tines // Dents de Râteau

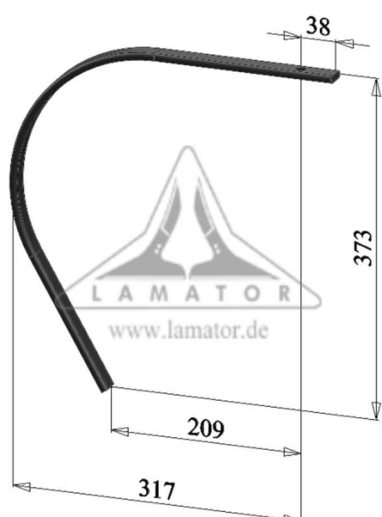
	Artikelbezeichnung Description // Dénomination	Artikel-Nr. Part Number le code article	Gewicht weight // poids
	❖ Rechenzinken		
	1-mal gelocht		
	- Standard 25 x 8	120 9162	0,94 kg
	- Verstärkt 32 x 10	120 9161	1,57 kg
	Rake Tine		
	1 hole		
- Standard 25 x 8	120 9162	0,94 kg	
- Strengthened 32 x 10	120 9161	1,57 kg	
Dent de Râteau			
1 trou			
- Standard 25 x 8	120 9162	0,94 kg	
- Renforcé 32 x 10	120 9161	1,57 kg	

Wendeschar // Reversible Points // Socs Reversibles

Artikelbezeichnung Description // Dénomination	Artikel-Nr. Part Number le code article	Gewicht weight // poid
---	---	---------------------------

Für Gareeggen Zinken // For Harrow Tines // Pour Dents herse Vibrantes



❖ Wendeschar 25 x 5 x 140 RAU für Planetschraube M8	120 8485	0,13 kg
Reversible Point 25 x 5 x 140 RAU for cultivator bolt M8	120 8485	0,13 kg
Soc Reversible 25 x 5 x 140 RAU pour boulon de soc M8	120 8485	0,13 kg
❖ Wendeschar 30 x 5 x 170	120 8486	0,18 kg
Wendeschar 40 x 6 x 135 für Planetschraube M10	120 7057	0,21 kg
Reversible Point 30 x 5 x 170	120 8486	0,18 kg
Reversible Point 40 x 6 x 135 for cultivator bolt M10	120 7057	0,21 kg
Soc Reversible 30 x 5 x 170	120 8486	0,18 kg
Soc Reversible 40 x 6 x 135 pour boulon de soc M10	120 7057	0,21 kg

Für Spurlockerer 40 x 10 und Schnellfluss-Zinken RAU // For Track Eradicators 40 x 10 and Easy-Flow Tine RAU // Pour l'Éfface-Trace 40 x 10 et Dent Écoulement Rapide RAU



❖ Wendeschar 40 x 6 x 199 für Planetschraube M10	120 8601	0,33 kg
Reversible Point 40 x 6 x 199 for cultivator bolt M10	120 8601	0,33 kg
Soc Reversible 40 x 6 x 199 pour boulon de soc M10	120 8601	0,33 kg

Wendeschar // Reversible Points // Socs Reversibles

Artikelbezeichnung Description // Dénomination	Artikel-Nr. Part Number le code article	Gewicht weight // poid
---	---	---------------------------

Für gebogene Zinken // For Bent Tines // Pour Dents Cintrés



❖ Wendeschar 40 x 6 x 200	120 5555	0,33 kg
Wendeschar 40 x 6 x 209	120 5676	0,35 kg
Wendeschar 40 x 6 x 215 für Planetschraube M10	120 6058	0,36 kg
Reversible Point 40 x 6 x 200	120 5555	0,33 kg
Reversible Point 40 x 6 x 209	120 5676	0,35 kg
Reversible Point 40 x 6 x 215 for cultivator bolt M10	120 6058	0,36 kg
Soc Reversible 40 x 6 x 200	120 5555	0,33 kg
Soc Reversible 40 x 6 x 209	120 5676	0,35 kg
Soc Reversible 40 x 6 x 215 pour boulon de soc M10	120 6058	0,36 kg

Für gerade Zinken // For Straight Tines // Pour Dents Droits



❖ Wendeschar gerade 40 x 6 x 135	120 7058	0,21 kg
Wendeschar gerade 40 x 6 x 215	120 7059	0,36 kg
Wendeschar gerade 40 x 6 x 220 für Planetschraube M10	120 7060	0,37 kg
Reversible Point straight 40 x 6 x 135	120 7058	0,21 kg
Reversible Point straight 40 x 6 x 215	120 7059	0,36 kg
Reversible Point straight 40 x 6 x 220 for cultivator bolt M10	120 7060	0,37 kg
Soc Reversible 40 x 6 x 135 droit	120 7058	0,21 kg
Soc Reversible 40 x 6 x 215 droit	120 7059	0,36 kg
Soc Reversible 40 x 6 x 220 droit pour boulon de soc M10	120 7060	0,37 kg

Wendeschar // Reversible Points // Socs Reversibles

Artikelbezeichnung Description // Dénomination	Artikel-Nr. Part Number le code article	Gewicht weight // poid
---	---	---------------------------

Für Großzinken 45 x 12 // For Extra Heavy Tines 45 x 12 // Pour Dents Forts 45 x 12



❖ Wendeschar 50 x 6 x 215	120 8541	0,43 kg
Wendeschar 60 x 6 x 215	120 8531	0,50 kg
Wendeschar 60 x 6 x 260 für Planetschraube M10	120 8521	0,66 kg
Reversible Point 50 x 6 x 215	120 8541	0,43 kg
Reversible Point 60 x 6 x 215	120 8531	0,50 kg
Reversible Point 60 x 6 x 260 for cultivator bolt M10	120 8521	0,66 kg
Soc Reversible 50 x 6 x 215	120 8541	0,43 kg
Soc Reversible 60 x 6 x 215	120 8531	0,50 kg
Soc Reversible 60 x 6 x 260 pour boulon de soc M10	120 8521	0,66 kg



❖ Wendeschar 60 x 6 x 300 2-Loch-Ausführung für Planetschraube M10	120 8525	0,79 kg
Reversible Point 60 x 6 x 300 with 2 holes for cultivator bolt M10	120 8525	0,79 kg
Soc Reversible 60 x 6 x 300 avec 2 trous pour boulon de soc M10	120 8525	0,79 kg

Breitschare // Shovels // Socs larges

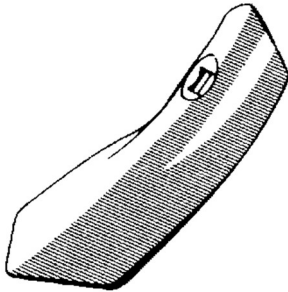
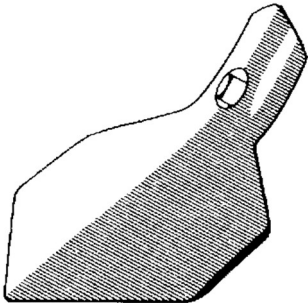
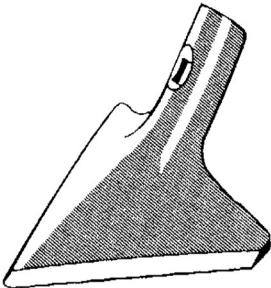
	Artikelbezeichnung Description // Dénomination	Artikel-Nr. Part Number le code article	Gewicht weight // poid
Für Sonderzinken mit optimierter Geometrie // For Special Tines with Optimized Shape // Pour Dents Spécials d'une Géométrie Optimisée			
	❖ Reißerschar „Made in Mexico“ 70 mm x 6 mm	120 8558	0,38 kg
	Shovel „Made in Mexico“ 70 mm x 6 mm	120 8558	0,38 kg
	Soc Sillonant „Made in Mexico“ 70 mm x 6 mm	120 8558	0,38 kg
	❖ Reißerschar „Made in Mexico“ 110 mm x 6 mm	120 8566	0,57 kg
	Shovel „Made in Mexico“ 110 mm x 6 mm	120 8566	0,57 kg
	Soc Sillonant „Made in Mexico“ 110 mm x 6 mm	120 8566	0,57 kg
	❖ Gänsefußschar „Made in Mexico“ 120 mm x 6 mm	120 8567	0,44 kg
	Duck Foot „Made in Mexico“ 120 mm x 6 mm	120 8567	0,44 kg
	Soc Patte d'Oie „Made in Mexico“ 120 mm x 6 mm	120 8567	0,44 kg

Breitschare // Shovels // Socs larges

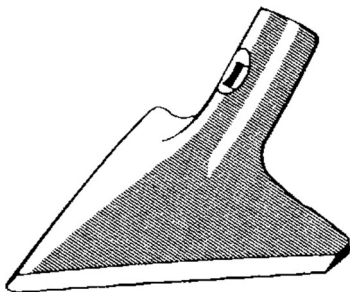
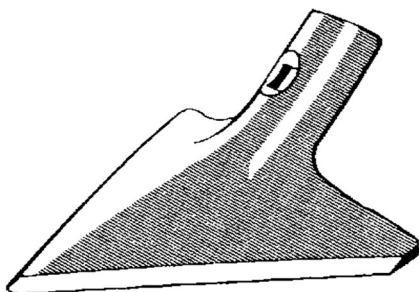
	Artikelbezeichnung Description // Dénomination	Artikel-Nr. Part Number le code article	Gewicht weight // poids
Für Sonderzinken mit optimierter Geometrie // For Special Tines with Optimized Shape // Pour Dents Spécials d'une Géométrie Optimisée			
	❖ Gänsefußschar „Made in Mexico“ 190 mm x 6 mm	120 8584	0,69 kg
	Duck Foot „Made in Mexico“ 190 mm x 6 mm	120 8584	0,69 kg
	Soc Patte d'Oie „Made in Mexico“ 190 mm x 6,25 mm	120 8584	0,69 kg
	❖ Gänsefußschar „Made in Mexico“ 240 mm x 6 mm	120 8585	0,84 kg
	Duck Foot „Made in Mexico“ 240 mm x 6 mm	120 8485	0,84 kg
	Soc Patte d'Oie „Made in Mexico“ 240 mm x 6 mm	120 8485	0,84 kg

***Klemmplatten (Zinkenhalter) für Geräterahmen im metrischen System //
Clamps for metric unit frames // Brides pour des cadres du système de mesures métrique***

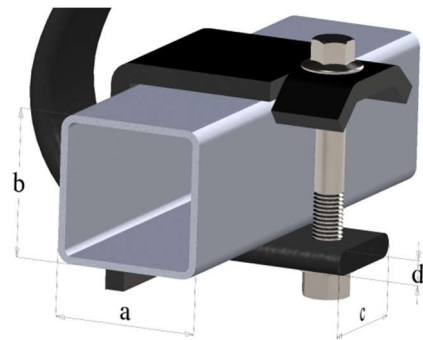
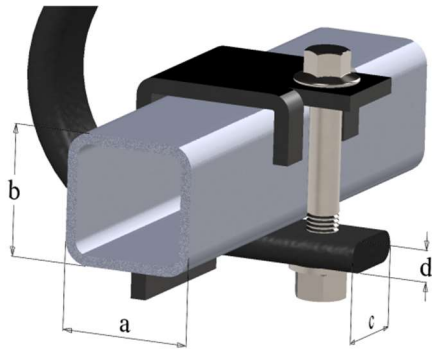

Artikelbezeichnung Description // Dénomination				Artikel-Nr. Part Number le code article	Gewicht weight // poids
Rahmenquerschnitt // Frame tran- section // Section transversale du cadre		Zinkenquerschnitt // Tine section // Section transversale du dent			
a	b	c	d		
80	80	90	13	120 8225	1,98 kg
60	60	60	12	120 8209	1,02 kg
60	60	50	13	120 8215	0,87 kg
60	60	45	12	120 8211	0,68 kg
60	60	45	10	120 8222	0,68 kg
60	60	45 – 4-kt-Loch	10	120 8222 1	0,63 kg
60	60	32	12	120 8219	0,70 kg
50	80	45	12	120 8210	0,68 kg
50	80	45 – M 16	12	120 8212	0,92 kg
50	50	60	12	120 8218	0,70 kg
50	50	45	12	120 9831	0,63 kg
50	50	45	10	120 8221	0,63 kg
50	50	32	12	120 9821	0,40 kg
50	50	32	10	120 8993	0,40 kg
50	30	32	10	120 5810	0,28 kg
50	15	32	12	120 8207	0,24 kg
50	15	32	10	120 8208	0,24 kg

Klemmplatten (Zinkenhalter) für Geräterahmen im metrischen System // Clamps for metric unit frames // Brides pour des cadres du système de mesures métrique

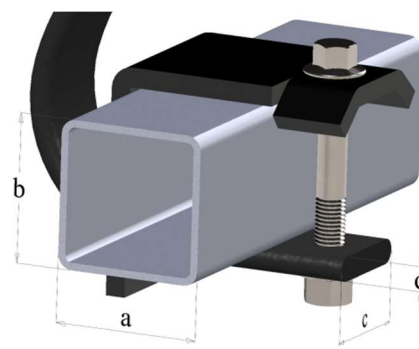
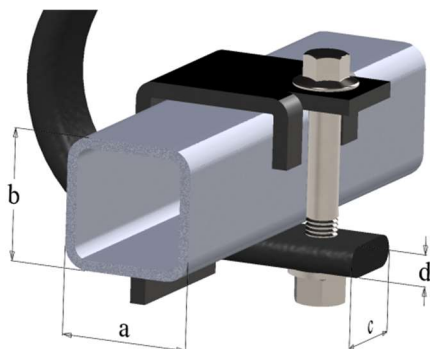

Artikelbezeichnung Description // Dénomination				Artikel-Nr. Part Number le code article	Gewicht weight // poids
Rahmenquerschnitt // Frame tran- section // Section transversale du cadre		Zinkenquerschnitt // Tine section // Section transversale du dent			
a	b	c	d		
50	12	45	12	120 6000	0,48 kg
50	12	45	10	120 8220	0,60 kg
50	12	32	12	120 5965	0,24 kg
50	12	32	10	120 5780	0,23 kg
50	10	32	12	120 5779	0,24 kg
50	10	32	10	120 5778	0,23 kg
40	40	45	12	120 6035 1	0,53 kg
40	40	45	10	120 8223	0,50 kg
40	40	32	12	120 6021	0,35 kg
40	40	32 – M 10	10	120 6020	0,36 kg
40	40	32 – M 12	10	120 6022	0,36 kg
40	25	32	10	120 6023	0,31 kg
40	12	32	10	120 6024	0,27 kg
40	12	25	8	120 6018	0,15 kg
40	10	32	10	120 6025	0,27 kg
40	10	25	8	120 6017	0,15 kg

***Klemmplatten (Zinkenhalter) für Geräterahmen im metrischen System mit Überfeder //
Clamps for metric unit frames with Helper Spring //
Brides pour des cadres du système de mesures métrique avec Ressort Subsidiaire***



Artikelbezeichnung Description // Dénomination				Artikel-Nr. Part Number le code article	Gewicht weight // poids
Rahmenquerschnitt // Frame tran- section // Section transversale du cadre		Zinkenquerschnitt // Tine section // Section transversale du dent			
a	b	c	d		
60	60	60	12	120 8224	1,03 kg
60	60	50	13	120 8217	0,88 kg
60	60	45	12	120 8213	0,70 kg
50	80 M 16	45	12	120 8214 1	0,91 kg
50	50	45	12	120 9832	0,60 kg
50	50	32	10	120 9834	0,41 kg
50	50	32	12	120 9835	0,41 kg
50	30	32	12	120 9950	0,35 kg

Klemmplatten (Zinkenhalter) für Geräterahmen im metrischen System mit Überfeder //
Clamps for metric unit frames with Helper Spring //
Brides pour des cadres du système de mesures métrique avec Ressort Subsidiaire

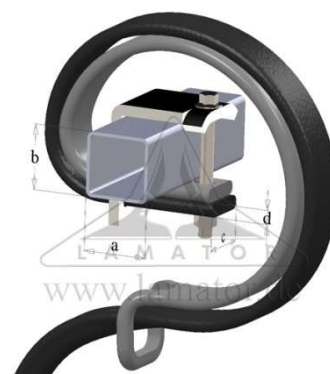

Artikelbezeichnung Description // Dénomination		Artikel-Nr. Part Number le code article	Gewicht weight // poid
Rahmenquerschnitt // Frame tran- section // Section transversale du cadre		Zinkenquerschnitt // Tine section // Section transversale du dent	
a	b	c	d
50	16	32 und Überfeder // Helper Spring Ressort Subsidiaire 32 x 10	10 120 5781 0,33 kg
50	12	32 und Überfeder // Helper Spring // Ressort Subsidiaire 32 x 10	12 120 9940 0,34 kg
50	12	32 und Überfeder // Helper Spring // Ressort Subsidiaire 32 x 10	10 120 9930 0,25 kg

Klemmplatten (Zinkenhalter) für Geräterahmen im Zoll-System // Clamps for inch unit frames // Brides pour des cadres du système de mesures reposant sur pouce

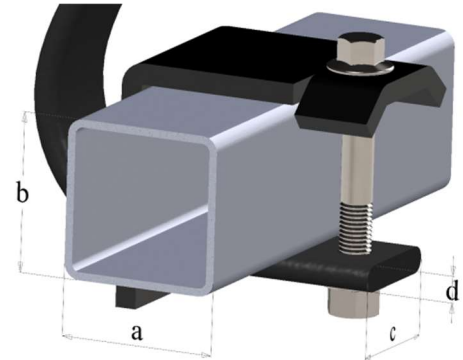
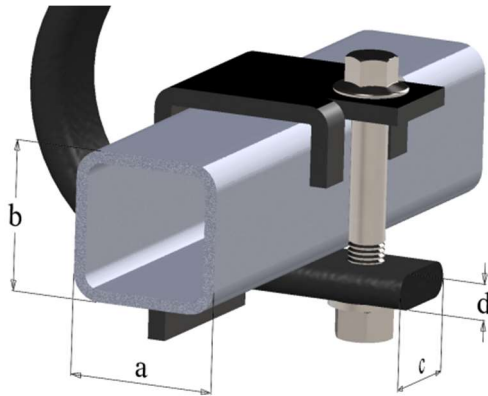

Artikelbezeichnung Description // Dénomination				Artikel-Nr. Part Number le code article	Gewicht weight // poids
Rahmenquerschnitt // Frame trans- section // Section transversale du cadre		Zinkenquerschnitt // Tine section // Section transversale du dent			
a	b	c	d		
3"	3"	45	12	120 9850	0,82 kg
2,5"	2,5"	45	12	120 9840	0,70 kg
2,5"	2,5"	32	12	120 9910	0,73 kg
2,5"	2,5"	32	10	120 9900	0,73 kg
2"	2"	45	12	120 9830	0,63 kg
2"	2"	32	12	120 9820	0,40 kg
2"	2"	32	10	120 8992	0,40 kg
1"	1"	25	8	120 9860	0,17 kg

Planetschrauben // Cultivator Bolts // Boulons de Soc

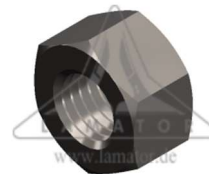

Artikelbezeichnung Description // Dénomination	Artikel-Nr. Part Number le code article	Gewicht weight // poids
<p>Planetschraube M8 x 33 / 6.6 mit Mutter</p> <p>Cultivator Bolt M8 x 33 / 6.6 with Nut Boulon de Soc M8 x 33 / 6.6 avec Écrou</p>	120 0833	0,02 kg
<p>Planetschraube M10 x 35 / 8.8 mit Mutter</p> <p>Cultivator Bolt M10 x 35 / 8.8 with Nut Boulon de Soc M10 x 35 / 8.8 avec Écrou</p>	120 1035	0,03 kg
<p>Planetschraube M10 x 37 / 8.8 mit Mutter</p> <p>Cultivator Bolt M10 x 37 / 8.8 with Nut Boulon de Soc M10 x 37 / 8.8 avec Écrou</p>	120 1037	0,03 kg
<p>Planetschraube M10 x 40 / 8.8 mit Mutter</p> <p>Cultivator Bolt M10 x 40 / 8.8 with Nut Boulon de Soc M10 x 40 / 8.8 avec Écrou</p>	120 1040	0,04 kg
<p>Planetschraube M10 x 45 / 8.8 mit Mutter</p> <p>Cultivator Bolt M10 x 45 / 8.8 with Nut Boulon de Soc M10 x 45 / 8.8 avec Écrou</p>	120 1045	0,04 kg
<p>Planetschraube M10 x 50 / 8.8 mit Mutter</p> <p>Cultivator Bolt M10 x 50 / 8.8 with Nut Boulon de Soc M10 x 50 / 8.8 avec Écrou</p>	120 1050	0,05 kg

***Umschlüsselungsliste für Nachbau-Ersatzteile // Recoding list for reproduction
replacement parts // Liste de codes pour pièces de rechange à reproduire***

Original-Nr. // Original // Numéro d'origine	Artikelbezeichnung Description // Dénomination	Artikel-Nr. Part Number le code article
passend für Amazonen-Werke und BBG		
	Federzinken 32 x 10 gerade, EH 380 mit Schar 40 x 6 x 215	120 0138
103555407	Wendeschar 40 x 6 x 215 gerade	120 7059
103555648	Zinkenfeder 32 x 10	120 8010
103550154	Zinken 32 x 12 Standard	120 8935
103555837	Wendeschar für Standardzinken W24	120 5555
103555392	SFZ 32 x 12 x 525 gerade 'Jack Pot' mit Schar 40 x 6 x 215	120 9131
103550138	Überfeder 32 x 10	120 9135
103552035	Schleppzinken 32 x 10, rechts	120 9606
103552043	Schleppzinken 32 x 10, links	120 9591
103552037	Abweiser 32 x 10, hinten lang	120 9165
103552038	Abweiser 32 x 10, kurz	120 9165 1
103555648	Zinkenfeder 32 x 10	120 8010
passend für Bednar		
KM060325	SFZ 45 x 12, gerade, EH 500 mit Schar 40 x 6 x 220	120 9156
KM060407	FZ-Wendeschar 40 x 6 x 220, gerade	120 7060
KM060152	GE-Kompaktzinken 32 x 10, gerade mit Schar 40 x 6 x 135	120 8480
KM060189	Schleppzinken 45 x 10, ohne Verschleißplatte, 4 x Ø 13 Lochung	120 8013 1
passend für Doublet Record		
042-2120	Uni-Federzinken 32 x 12 x 500 mit Schar 40 x 6 x 215	120 0144
042-2020	Wendeschar 40 x 6 x 215	120 6058
passend für Farmet		
M05406	Federzinken 32 x 10 gerade, EH 380 mit Schar 40 x 6 x 215	120 0138

***Umschlüsselungsliste für Nachbau-Ersatzteile // Recoding list for reproduction
replacement parts // Liste de codes pour pièces de rechange à reproduire***

Original-Nr. // Original // Numéro d'origine	Artikelbezeichnung Description // Dénomination	Artikel-Nr. Part Number le code article
passend für Frost		
50240	Federzinken 32 x 10 Standard mit Schar 40 x 6 x 200 W24	120 9011
50241	Wendeschar für Standardzinken W24	120 5555
	Überfeder 32 x 10	120 9135
passend für Horsch		
00310085	Schleppzinken 45 x 10	120 8110
00310092	Verschleißplatte 45 x 10 gerade	120 8014 1
00330198	Packerfeder 70 x 10	120 9708
00330141	Packerfeder 60 x 9 RollFlex-Walze	120 9710
34283704	Packerzwischenfeder 60 x 9 1-Loch	120 9711
00330109	Packerzwischenfeder 60 x 9 2-Loch	120 9712
34265006	Verschleißplatte 45 x 10 gekantet	120 8019
23250301	Striegelblattfeder 50 x 6	120 9713
00330142	Packerfeder 70 x 9	120 9714
34286011	Schneide für RollCut 6 x 140 x 445	ab Baujahr 2008 120 9702
passend für Köckerling		
633 238	Abstreifer 50 x 10	120 9570
904 478	Zwischenfeder 45 x 10	120 9571
903 474	Walzenplatte / Scharplatte 100 x 8	120 8026
905 238	Walzenplatte / Scharplatte 80 x 8	120 8027

***Umschlüsselungsliste für Nachbau-Ersatzteile // Recoding list for reproduction
replacement parts // Liste de codes pour pièces de rechange à reproduire***

Original-Nr. // Original // Numéro d'origine	Artikelbezeichnung Description // Dénomination	Artikel-Nr. Part Number le code article
passend für Kongskilde		
101 200 236	Gareeggen-Zinken 32 x 10 'Germinator' mit Schar 40 x 6 x 135	120 8480
101 000 740	Federzinken 32 x 12 'SQ' mit Schar 40 x 6 x 215	120 0261
101 000 745	Zinken 32 x 12 'SQ' ohne Schar	120 0260
101 000 019	Wendeschar 40 x 6 x 215	120 6058
01.000.636	Standard-Federzinken 32 x 10 x 560 mit Schar 40 x 6 x 200 W24	120 9011
01.000.637	Standard-Zinken 32 x 10 x 560 W24	120 8902
500 068 401	Steinsammler-Zinken 32 x 12 'Stonebear'	120 8945a
500 068 402	Überfeder 32 x 10 'Stonebear'	120 9135
passend für Kverneland		
KK 300 500	Federzinken 45 x 10 mit Schar 40 x 6 x 215	120 0265
KK 300 502	Federzinken 32 x 10 mit Schar 40 x 6 x 215	120 0263
KK 103 011	Wendeschar 40 x 6 x 215	120 6058
KW 111099002	Federzinken 32 x 12 gerade, EH 450 mit Schar 40 x 6 x 215	120 0245
KW 111099000	Wendeschar 40 x 6 x 215 gerade	120 7059
KW 111099009	Wendeschar 40 x 6 x 200	120 5555
KW 111099012	Schar für Schleppzinken 45 x 12	Auf Anfrage
RG00012144	Schnellfluss-FZ 32 x 10 x 560 mit Schar 40 x 6 x 199	120 0250
RG00009724	Wendeschar 40 x 6 x 199	120 8601
RG00019933	GEZ 25 x 8 analog RAU mit Schar 25 x 5 x 140	120 8470
RG00012158	GEZ 25 x 8 analog RAU, gebogen	120 8471
RG00007748	GEZ 25 x 8 analog RAU, gerade, vorn	120 8472
RG00017591	Schleppzinken 32 x 10, links	120 9591

***Umschlüsselungsliste für Nachbau-Ersatzteile // Recoding list for reproduction
replacement parts // Liste de codes pour pièces de rechange à reproduire***

Original-Nr. // Original // Numéro d'origine	Artikelbezeichnung Description // Dénomination	Artikel-Nr. Part Number le code article
passend für Lemken		
353 5000	Gareeggen-Zinken 25 x 8 lang, gebogen	120 8822
353 4996	Gareeggen-Zinken 25 x 8, lang, gerade, vorn	120 8830
353 8721	Federzinken 32 x 10 x 560 Schnellfluss	120 9011
337 5476	Wendeschar für Standardzinken 32 x 10 x 560	120 5555
337 5475	Wendeschar 30 x 5 x 170 für GEZ 353 5006	120 8486
337 10001	Wendeschar 40 x 6 x 215 gerade	120 7059
353 5516	GAMMA-Zinken 32x12 D22 mit Schar	150 5103
337 5480	Schar für GAMMA-Zinken D22 K4 8x40x160	120 7090
353 8626	Federzinken MARATHON 30x12-D22 ohne Schar	150 8935
353 8726	Federzinken MARATHON 30x12-D22 mit Schar	150 9028
passend für Pöttinger		
1210010	Wendeschar 40 x 6 x 200	120 5555
91.15.164.01	Großzinken 50 x 13 x 660	120 9350

***Umschlüsselungsliste für Nachbau-Ersatzteile // Recoding list for reproduction
replacement parts // Liste de codes pour pièces de rechange à reproduire***

Original-Nr. // Original // Numéro d'origine	Artikelbezeichnung Description // Dénomination	Artikel-Nr. Part Number le code article
passend für Grégoire Besson / Rabe		
8007.63.00	Gareeggen-Zinken 32 x 10 ‚Germinator‘ mit Schar 40 x 6 x 135	120 8480
8007.63.02	Wendeschar 40 x 6 x 135 gerade	120 7058
6242.06.01	Gareeggen-Zinken 25 x 8 kurz, gerade, vorn	VEG 8 120 8847
6242.07.01	Gareeggen-Zinken 25 x 8 kurz, gebogen	VEG 9 120 8814 2
8007.42.02	Federzinken 32 x 12 x 560 Schnellfluss	VEG 16 120 9028 2
8007.42.01	Zinken 32 x 12 x 560 Schnellfluss	VEG 16 120 8935
8007.18.03	Wendeschar 40 x 6 x 200	120 5555
6251.77.03	Wendeschar 40 x 6 x 215 gerade	120 7059
passend für Rasspe		
RS 2977 S	Standard-Federzinken 32 x 10 x 560 W24	120 9011
RS 2977 D	Federzinken 32 x 12 Standard W24	120 9028
RS 2977	Schnellfluss-Federzinken 32 x 10 x 560 mit Schar 40 x 6 x 199	120 0250
RS 0138	Federzinken 32 x 10 gerade mit Schar 40 x 6 x 215, EH 380 mm	120 0138
RS 0245	Federzinken 32 x 12 gerade mit Schar 40 x 6 x 215, EH 450 mm	120 0245
RS 9131	Federzinken 32 x 12 gerade ‚Jack Pot‘ mit Schar 40 x 6 x 215	120 9131
RS 9121	Kulti-Kompakt-Federzinken 45x12 mit Schar 40 x 6 x 200	120 9121
RS 2986 HC	Großfederzinken 45 x 12 x 660 mit Schar 50 x 6 x 215	120 8381
RS 2987 HC	Großfederzinken 45 x 12 x 660 mit Schar 60 x 6 x 215	120 8382
RS 2988 HC	Großfederzinken 45 x 12 x 660 mit Schar 60 x 6 x 260	120 8383
RS 2982 L	Gareeggen-Zinken 25 x 8 lang, gebogen	120 8822
RS 2982 GL	Gareeggen-Zinken 25 x 8 kurz, gerade, vorn	120 8847
RS 2982 SCH	Gareeggen-Zinken 25 x 8 mit Schar 30 x 5 x 170	120 8461
RS 8470	Gareeggen-Zinken 25 x 8 gebogen RAU mit Schar 25 x 5 x 140	120 8470

***Umschlüsselungsliste für Nachbau-Ersatzteile // Recoding list for reproduction
replacement parts // Liste de codes pour pièces de rechange à reproduire***

Original-Nr. // Original // Numéro d'origine	Artikelbezeichnung Description // Dénomination	Artikel-Nr. Part Number le code article
passend für Rasse		
RS 8480	Gareeggen-Zinken 32 x 10 ‚Germinator‘ mit Schar 40 x 6 x 135	120 8480
RS 2974 D	Überfeder 32 x 10	120 9135
RS 9138	Überfeder 45 x 10	120 9138
RS 9591	Schleppzinken 32 x 10 links	120 9591
RS 9606	Schleppzinken 32 x 10 rechts	120 9606
RS 3030	Spurlockerer 32 x 10 kurz	120 9614
RS 3031	Spurlockerer 40 x 10 lang	120 9542
RS 8010	Zinkenfeder 32 x 10	120 8010
RS 2978 S	Wendeschar 40 x 6 x 200 für Standardzinken W24	120 5555
RS 2978 S 210 mm	Wendeschar 40 x 6 x 215	120 6058
RS 2983	Wendeschar 30 x 5 x 170	120 8486
RS 2928	Wendeschar 40 x 6 x 135	120 7057
RS 7058	Wendeschar 40 x 6 x 135 gerade	120 7058
RS 7059	Wendeschar 40 x 6 x 215 gerade	120 7059
RS 2989 A HC	Wendeschar 50 x 6 x 215 für Großfederzinken	120 8541
RS 2989 B HC	Wendeschar 60 x 6 x 215 für Großfederzinken	120 8531
RS 2989 HC	Wendeschar 60 x 6 x 260 für Großfederzinken	120 8521
passend für RAU		
0012158	Gareeggen-Zinken 25 x 8 RAU, gebogen	120 8471
0007748	Gareeggen-Zinken 25 x 8 RAU, gerade, vorn	120 8472
E19933	Gareeggen-Zinken 25 x 8 RAU, mit Schar 25 x 5 x 140	120 8470
E19935	Wendeschar 25 x 5 x 140 für Gareeggen-Zinken	120 8485
57503	Federzinken 32 x 10 x 560 Standard W24 mit Schar 40 x 6 x 200	120 9011
0055551	Wendeschar für Standardzinken W24	120 5555
0012144	Schnellfluss-Federzinken 32 x 10 mit Schar 40 x 6 x 199	120 0250

***Umschlüsselungsliste für Nachbau-Ersatzteile // Recoding list for reproduction
replacement parts // Liste de codes pour pièces de rechange à reproduire***

Original-Nr. // Original // Numéro d'origine	Artikelbezeichnung Description // Dénomination	Artikel-Nr. Part Number le code article
passend für RAU		
0009724	Wendeschar 40 x 6 x 199 für Schnellfluss-Zinken	120 8601
E17592	Schleppzinken 32 x 10 rechts	120 9606
E17591	Schleppzinken 32 x 10 links	120 9591
RF 07927	SFZ 32 x 12 x 490 gerade mit Schar 40 x 6 x 215 gerade, mit Ø 13	120 9141
passend für Väderstad		
400525	Federzinken 32 x 10 Standard	120 9013
201070	Federzinken 45 x 10 Universal	120 9171
201470	Federzinken 45 x 10 Agrilla Nova	120 9123
201064-71	Federzinken 45 x 10 Agrilla Super	120 9173
428797	Federzinken 45 x 10 Agrilla Cobra	120 9175
400523	Wendeschar 40 x 6 x 215	120 6058
201787	Schleppzinken 45 x 10 (ohne Verschleißplatte)	120 8013
419998-1 / 416256	Verschleißplatte 45 x 10, gerade	120 8014
419997-1 / 415409	Verschleißplatte 45 x 10, gekantet	120 8015
419999-1 / 415872	Verschleißplatte 100 x 8, gekantet	120 8016
420330	Verschleißplatte 150 x 8, gekantet	120 8017
	Verschleißplatte 150 x 8, gekantet und ausgeklinkt	120 8018
419996-1 / 416256	Verschleißplatte 100 x 8, gerade	120 8026
425587-1	Verschleißplatte 150 x 8, gerade	Auf Anfrage

Anmerkungen zu unserem Programm

- ❖ Wir sind bestens auf die Entwicklung von Produkten nach Kundenwunsch eingerichtet. Für Gerätehersteller ist es von Vorteil, für ihre Geräte individuell für sie entwickelte Werkzeuge zu verwenden.
- ❖ Unsere Entwicklungsabteilung ist mit einem 3D-CAD-System ausgestattet und mit den CNC-Werkzeugmaschinen unseres Werkzeugbaus vernetzt. Deswegen ist die Realisierung von neuentwickelten Zinken und Scharen ohne großen Zeitverzug möglich.
- ❖ Alle Bodenbearbeitungswerkzeuge werden in schwarzer Einbrennlackierung geliefert. Sie sind auf Paletten gestapelt und in Schrumpffolie witterungsbeständig verpackt.
- ❖ Die Stückzahlen je Palette betragen für
 - Standard-Zinken 200 Stück oder 250 Stück
 - Großzinken 150 Stück
 - Gareeggen-Zinken 500 Stück oder 600 Stück
 - Schare und Klemmplatten 1.000 Stück bis 3.000 Stück
- ❖ Auf Kundenwunsch werden auch Paletten mit Mischware geliefert.
- ❖ Wir bitten Sie, individuell auf Ihre Ansprüche abgestimmte Anfragen an uns zu richten.
- ❖ Technische Änderungen und Irrtümer vorbehalten. Abbildungen ähnlich.
- ❖ Alle Maßangaben sind in mm. Diese und die Gewichtsangaben sind unverbindlich und dienen der Orientierung. Es gelten die allgemeinen Toleranzen für in Warmumformung hergestellte Teile.
- ❖ Die Angabe der Original-Ersatzteilnummer dient ausschließlich Vergleichszwecken.
- ❖ Die Abbildungen dienen lediglich der Visualisierung. Andere Farben sind auf Wunsch gegen Aufpreis lieferbar.
- ❖ Alle Artikel sind auf Wunsch auch ohne Schar lieferbar.

Nachdruck, auch auszugsweise, ist untersagt und bedarf der schriftlichen Genehmigung.

Comments about our Program

- ❖ Our strength is the development of parts to customer's specifications. Especially for manufacturers it is an advantage to use custom made products.
- ❖ Our engineering department is equipped with a 3D CAD system which is linked up to the CNC machinery of our tool design department. That is why the creation of new custom made parts can be realized immediately.
- ❖ All parts come with a glossy black finish and are bundled and palletized. Pallets are covered with weather resistant shrink wrap.
- ❖ The number of parts per pallet are for
 - Standard tines: 200 or 250 pieces
 - Big tines: 150 pieces
 - Harrow tines: 500 or 600 pieces
 - Points and clamps: 1,000 to 3,000 pieces
- ❖ On request we can also prepare pallets with different products.
- ❖ You are welcome to contact us for any special requirements.
- ❖ Specifications are subject to change without notice.
- ❖ All dimensions are in mm. They and the indications of weight are not binding and only for orientation. General tolerances for hot forming parts apply.
- ❖ The original spare part numbers used in this catalogue are for comparison purposes only.
- ❖ All pictures, descriptions, diagrams and illustrations only intend to give a general impression of our products. Dimensions shown are for information only and are subject to technical alterations. Other product colors are available at an extra charge.
- ❖ All tines are available without points as well.

Prior to any form of reproduction written permission is required.

Remarques sur notre Programme

- ❖ Nous sommes parfaitement préparés pour le développement de produits conformément au souhait des clients. Les fabricants d'appareils profitent du fait de pouvoir utiliser, pour leurs appareils, des outils développés individuellement pour eux.
- ❖ Notre service développement est équipé d'un système CAO 3D et des machines-outils à commande numérique de notre service construction d'outils. C'est pourquoi il est possible de réaliser des dents et des socs nouvellement développés dans grande perte de temps.
- ❖ Les outils de travail du sol sont tous livrés avec vernis à cuire noir. Ils sont empilés sur des palettes et emballés dans des films rétractables résistant aux intempéries.
- ❖ La quantité par palette et de
 - 200 ou 250 unités pour les dents standard
 - 150 unités pour grandes dents
 - 500 ou 600 unités pour les dents herse
 - 1.000 à 3.000 unités pour les socs et plaques de serrage
- ❖ A la demande des clients, nous livrons également des palettes avec différentes marchandises.
- ❖ Nous vous prions de nous adresser les demandes conformes à vos exigences individuelles.
- ❖ Sous réserve de modifications techniques ou d'erreurs. Similaire aux illustrations.
- ❖ Toutes les cotes sont indiquées en mm. Eux et les indications de masse ne sont pas fermes et ne servent que de repère. Les tolérances générales pour les pièces fabriquées par formage à chaud s'appliquent.
- ❖ L'indication des numéros de pièces de rechange d'origine n'est donnée qu'à des fins de comparaison.
- ❖ Les illustrations ne servent qu'à la visualisation. Autres couleurs sur demande moyennant supplément de prix.
- ❖ Sur demande, les articles peuvent tous être livrés également sans soc.

Toute impression, même partielle, est interdite et nécessite l'autorisation écrite.

**Prager Straße 1
D 04860 Torgau**

Telefon: +49 (0) 3421 / 77 37 6 - 0
Fax: +49 (0) 3421 / 77 37 6 - 40

eMail: info@lamator.de
Internet: www.lamator.de

